



COLD
ROOMS AND
REFRIGERATED
CABINETS
PROFILES

 **mpm**
HYGIENIC PROFILES

FEBRUARY 2022



WE PRESENTS
OUR NEW LINES
AND **OUR NEW
PROFILES' CREATIONS**



ALWAYS CREATED FOR YOUR NEEDS
ALWAYS THE BEST COLD SYSTEMS PROFILES

CONTENTS

01	Guard Rails and Bollards	page 08	15	Gaskets	page 66
02	PVC Panels	page 20	16	Accessories for panels	page 70
03	Foamed System	page 22	17	Trims	page 74
04	Hermetic System	page 24	18	T Suspension	page 76
05	Standard System	page 28	19	Bumper 30	page 78
06	Speed System	page 32	20	Bumper 50	page 80
07	Modular System	page 36	21	Bumper 80	page 82
08	Channels	page 40	22	Bend 80	page 84
09	Fixer System	page 44	23	Bumper Superflex 80	page 86
10	Pillar System	page 48	24	Bumper Modular	page 88
11	Kerb	page 50	25	Wall Protection	page 90
12	Antishock System	page 54	26	Bumper 150	page 94
13	Door Frame	page 56	27	Bumper Floor	page 96
14	Door Leaf	page 62	28	Wheel System	page 100

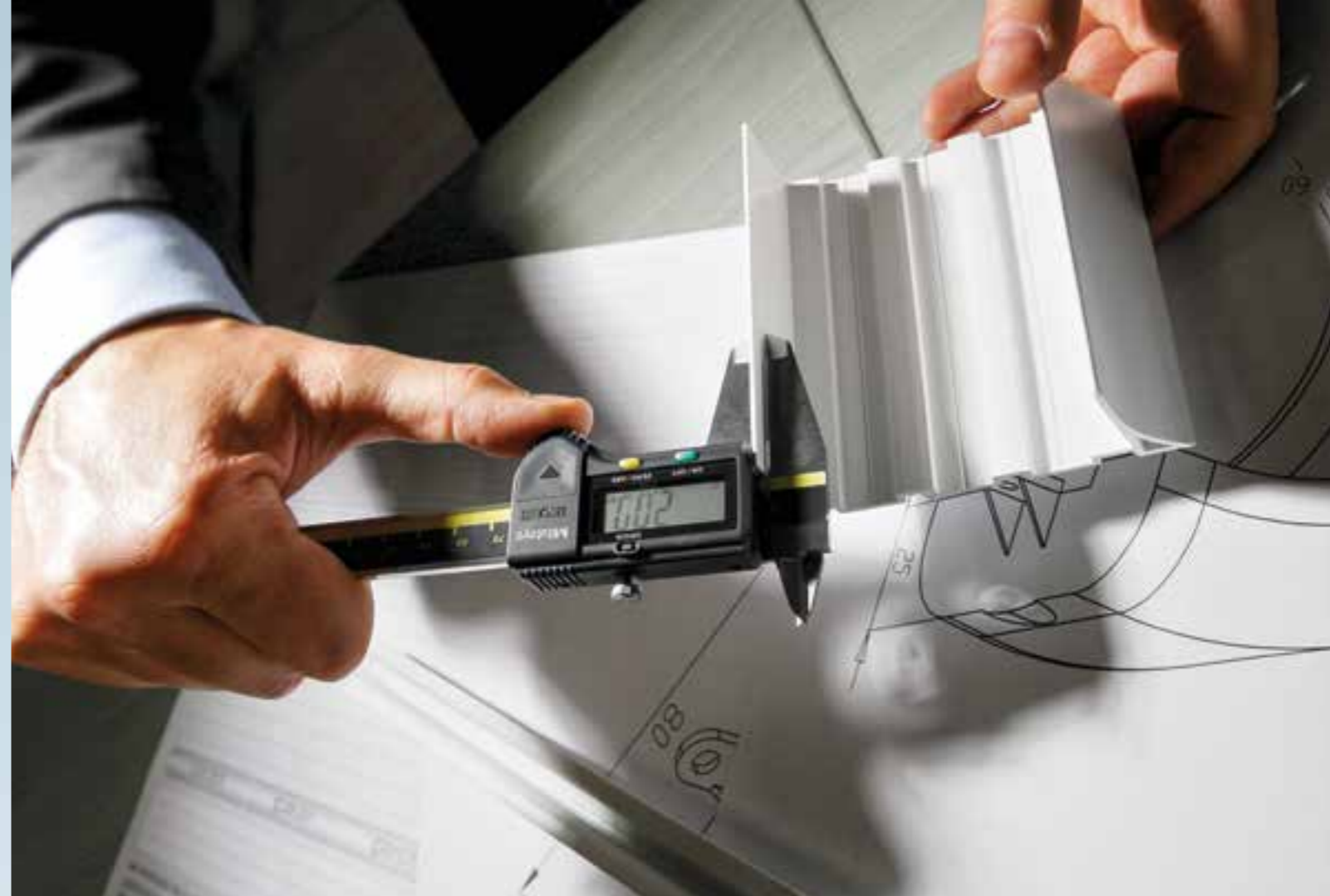

THE COMPANY L'AZIENDA

TURNKEY PRODUCTS ON DEMAND

Right from the customer's request the company follows project development, production through to the final product. Our technical team deals with each stage of the project, mould production and testing aimed at offering the best solutions.

MPM A GROWING COMPANY

The quality of M.P.M products is the result of combining the skills and motivation of a team with advanced materials and technologies. Dynamic, enterprising and flexible this company has been serving the plastics industry since 1985 offering extruded plastic profiles to order as well as a range of its own products.

PRODOTTI SU MISURA CHIAVI IN MANO

L'azienda segue fin dal primo stadio la realizzazione del progetto, dalla richiesta del cliente al prodotto finito. Lo staff tecnico cura le diverse fasi di progettazione, la costruzione degli stampi e il collaudo, attento a proporre le soluzioni migliori.

UN'AZIENDA IN CRESCITA

La qualità dei prodotti M.P.M. deriva dalla riuscita combinazione tra le competenze e la motivazione dell'equipe di lavoro e l'alto livello delle tecnologie e dei materiali. Dinamica, intraprendente e flessibile, l'azienda lavora dal 1985 al servizio della più esigente imprenditoria nell'impegnativo settore dell'estrusione di materie plastiche, producendo profili per conto terzi e su proprio catalogo.

CUSTOMIZED PRODUCTS PRODOTTI PERSONALIZZATI

ALWAYS DYNAMIC, ALWAYS RELIABLE

Young yet skilled in offering turnaround solutions to satisfy the various problems this market faces, the staff at M.P.M, a team of technicians and experts motivated and qualified in their fields, combine superior quality with fast product production.

3D DESIGN

The company has invested substantially in design: advanced 3D software and product prototype development has led to a reduction in problems and errors in mould manufacturing.

SEMPRE DINAMICA, SEMPRE AFFIDABILE

Giovane ma adeguatamente preparato a risolvere con tempestività le diverse problematiche insite nel difficile settore, lo staff M.P.M. è composto da tecnici e professionisti motivati, efficienti e capaci di coniugare l'eccellenza qualitativa con la massima rapidità nell'esecuzione del prodotto.

PROGETTAZIONE 3D

L'azienda ha investito molto nel campo della progettazione: l'utilizzo di avanzati software 3D e la successiva prototipazione rapida hanno consentito la riduzione di inconvenienti ed errori nella fase di produzione dello stampo.



360° GLOBAL SERVICE UN SERVIZIO A 360°



1 PROJECT PLAN
STUDIO PROGETTO



2 MOULD MANUFACTURING
PRODUZIONE STAMPO



3 MOULD REALIZED
STAMPO FINITO

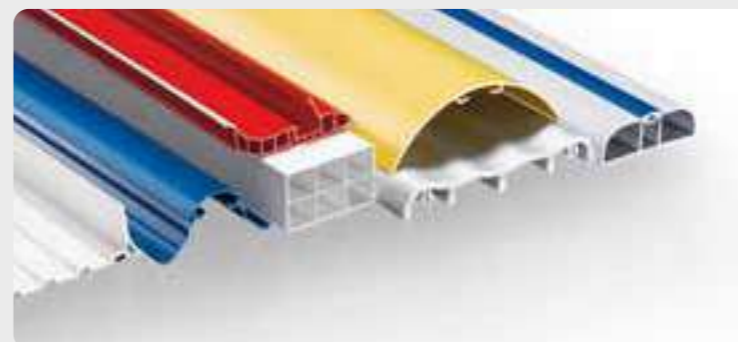

5 PRODUCTS RANGE
GAMMA PRODOTTI



4 PROFILES MANUFACTURING
PRODUZIONE PROFILI

6 EXPORT





DETAILED SOLUTIONS SOLUZIONI MIRATE

SOLUTIONS FOR DIFFERENT FIELDS

Thanks to the close working partnership with specialist laboratories, M.P.M. develops product mixes ideal for extruding rigid, expanded, co-extruded profiles and for producing soft seals of varying hardness. The products are available with polished or matt finishes for interior and exterior use, they can be anti-shock, self-extinguishing, acid resistant satisfying requirements of a number of industries spanning from furniture, refrigeration, door and window producers to the building trade.

ABS	acrylonitrile butadiene styrene
PE	polyethylene
TPE	thermoplastic rubber
SEBS	thermoplastic rubber
PMMA	polymethyl methacrylate
PP	polypropylene
PS	polystyrene
PVC	polyvinyl chloride
PVCE	expanded foam polyvinyl chloride
PUR	polyurethane

SOLUZIONI PER OGNI SETTORE

Grazie alla collaborazione di laboratori specializzati, M.P.M. progetta le miscele di materiale più adatte all'estrusione di profili rigidi, espansi, coestrusi e di guarnizioni morbide a diversa durezza. I prodotti possono essere con finiture lucide od opache, per interni o esterni, antiurto, autoestinguenti e resistenti agli acidi, soddisfacendo in particolare le esigenze delle industrie del mobile, del freddo, del serramento e dell'edilizia.

ABS	acrilonitrile-butadiene-stirolo
PE	polietilene
TPE	gomma termoplastica
SEBS	gomma termoplastica
PMMA	polimetilmetacrilato
PP	polipropilene
PS	polistirolo-polistirene
PVC	policloruro di vinile
PVCE	policloruro di vinile espanso
PUR	poliuretano

01

GUARD RAILS AND BOLLARDS

Guard Rails è un sistema di profili antiurto specifico per la protezione delle pareti dai carrelli in movimento. Progettato seguendo un innovativo disegno tecnico che coniuga rapidità e semplicità nelle fasi di installazione e pulizia. Disponibile in diverse lunghezze.

Guard Rails is a new bumper system specific for the protection of the walls resistant against trolleys movements. Designed by following an innovative technical design that combines speed and simplicity in the steps of installation and cleaning. Available in different lengths.

Guard Rails est un nouveau système bumper, spécifique pour protéger les murs contre les mouvements des charriots. Étudié avec un modern dessin qui regroupe la rapidité et la facilité pendant l'installation et le nettoyage. Disponible en différents longueurs.

Bollard è ideato per proteggere l'accesso a cancelli o portoni dalla movimentazione di mezzi pesanti o semplicemente per impedire l'ingresso di pedoni. Provvisto di accessori di fissaggio.

Bollard is designed to protect access to gates or big doors from huge traffic or simply to mark restricted areas for pedestrians. Fully equipped with fixing accessories.

Bollard est étudié pour protéger l'accès aux portes ou entrées de grand trafic ou simplement pour marquer les zones de passage piétons. Equipé avec les accessoires d'installation.



ROD 70

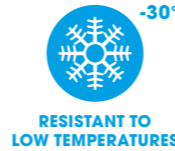

Guard Rails and Bollards



Fixing accessory available also in stainless steel



ROD 70 266

Drill Ø 38
Equipped with accessories

Packing Colour 1 pz / box
M

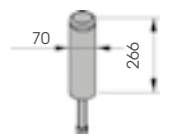

ROD 120



REMOVABLE
EASY TO REMOVE AND TO REPLACE

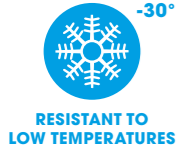

Fixing accessory available also in stainless steel



ROD 120 433
560
800

Packing Colour **M**
1 pz / bag

Drill \varnothing 56
Equipped with accessories

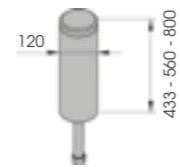

ROD FLOOR 70



QUICK INSTALLATION WITH EXPANSION SCREW



M16 GALVANISED STEEL

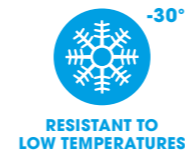

RF 70 500
1000
1500

Length 500 / 1000 / 1500 mm
Packing unpacked on pallet
Colour **M**

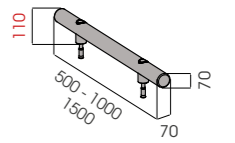

Equipped with accessories



RF 70 2000
3000

Length 2.000 / 3.000 mm
Packing unpacked on pallet
Colour **M**

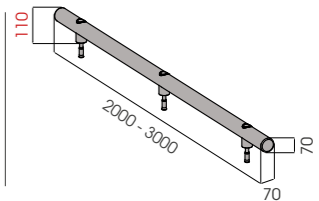

Equipped with accessories



ROD FLOOR 100



HIGH RESISTANCE WITH RESIN



SF20 STAINLESS STEEL

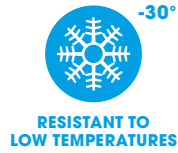

RF 100 500
1000
1500

Length 500 / 1000 / 1500 mm
Packing unpacked on pallet
Colour **M**

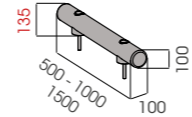

Equipped with accessories



RF 100 2000
3000

Length 2.000 / 3.000 mm
Packing unpacked on pallet
Colour **M**

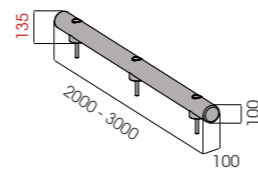

Equipped with accessories



ROD FLOOR 120



HIGH RESISTANCE WITH RESIN



SF20 STAINLESS STEEL

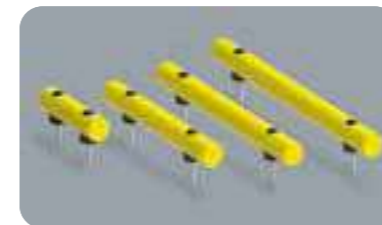

RF 120 500
1000
1100
1500

Length 500 / 1000 / 1100 / 1500 mm
Packing unpacked on pallet
Colour **M**

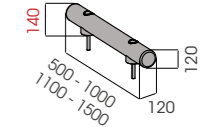

Equipped with accessories



RF 120 2000
2500
3000

Length 2.000 / 2.100 / 3.000 mm
Packing unpacked on pallet
Colour **M**

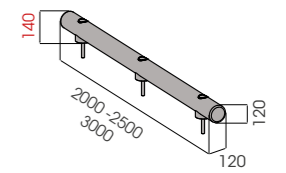

Equipped with accessories



ROD FLOOR 120 DOUBLE RE



HIGH RESISTANCE WITH RESIN



NOT SHARP EDGES



RESISTANT TO LOW TEMPERATURES



RF 120 DOUBLE 1100

Length **1100 mm**
Packing **unpacked on pallet**
Colour **M**

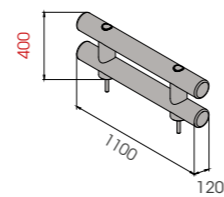

Equipped with accessories

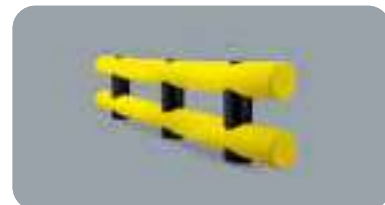

RF 120 DOUBLE 2500

Length **2.500 mm**
Packing **unpacked on pallet**
Colour **M**

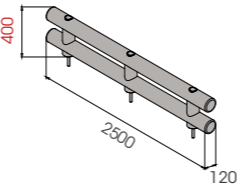

Equipped with accessories



ROD FLOOR 120 DOUBLE



HIGH RESISTANCE WITH RESIN



RESISTANT TO LOW TEMPERATURES



**RF 120 DOUBLE 500
1000
1500**

Length **500 / 1000 / 1500 mm**
Packing **unpacked on pallet**
Colour **M**

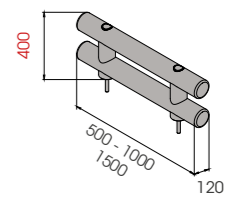

Equipped with accessories



**RF 120 DOUBLE 2000
3000**

Length **2.000 / 3.000 mm**
Packing **unpacked on pallet**
Colour **M**

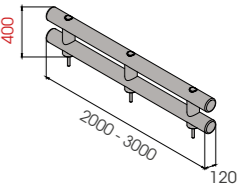

Equipped with accessories



GRD 90



FAST AND EASY TO INSTALL



M12 GALVANISED STEEL

GRD 150



FAST AND EASY TO INSTALL



M12 GALVANISED STEEL



GRD 90 250

Packing Colour **B** **M** unpacked on pallet

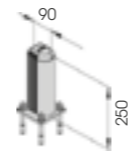

Equipped with accessories



GRD 150 * 500
800
1150

Packing Colour **B** **M** unpacked on pallet

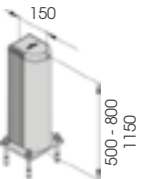

Equipped with accessories



GUARD RAIL 90



QUICK INSTALLATION WITH EXPANSION SCREW



M16 GALVANISED STEEL



ALTERNATIVE FIXING HIGH RESISTANCE WITH RESIN **SF16 STAINLESS STEEL**



GR 90 500
750
1000
1500

Length 500 mm
Packing unpacked on pallet

Length 750 / 1000 / 1500 mm
Packing 2 pz / box

Colour **B** **M**

Equipped with accessories

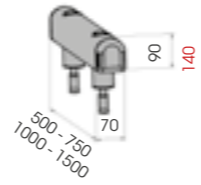

GR 90 2000
3000
4000

Length 2.000 / 3.000 / 4.000 mm
Packing unpacked on pallet

Colour **B** **M**

Equipped with accessories

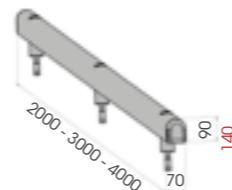

GUARD RAIL 150



HIGH RESISTANCE WITH RESIN



SF20 STAINLESS STEEL



GR 150 500
750
1000
1500

Length 500 / 750 / 1000 / 1500 mm
Packing unpacked on pallet

Colour **B** **M**

Equipped with accessories

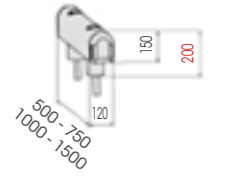

GR 150 2000
3000
4000

Length 2.000 / 3.000 / 4.000 mm
Packing unpacked on pallet

Colour **B** **M**

Equipped with accessories

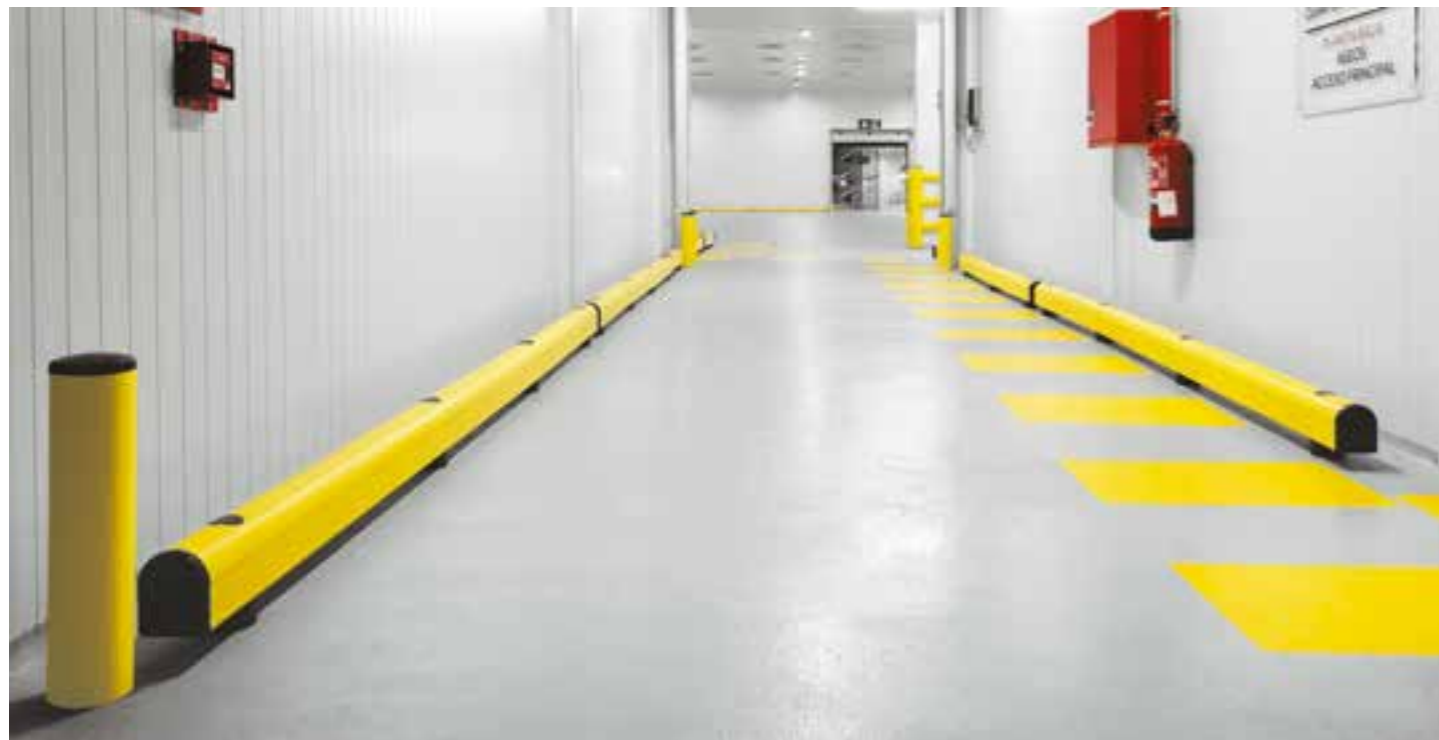
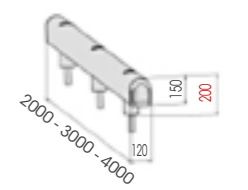

02 PVC PANELS













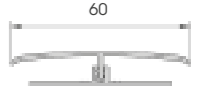

PVC sheets to renovate fastly and cheaply the walls of cold rooms and cold store.

Lastre in PVC per il rinnovo rapido ed economico delle pareti nelle celle e nei magazzini frigoriferi.

Plaques en PVC pour renover rapidement et a bas prix les murs de chambres froides et de depots frigorifiques.

DIFFERENT SIZES ON REQUEST

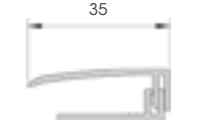
	PF 300		Length Packing Colour	3.000 / 4.000 mm 3 pz / bag E	
	PR 300		Length Packing Colour	3.000 / 4.000 mm 3 pz / bag E	
	PJ To install with PR 300 and PF 300		Length Packing Colour	3.000 mm 10 pz / box E	
	PJR To install with PR 300		Length Packing Colour	3.000 mm 20 pz / bag E	
	PA To install with PR 300 and PF 300		Length Packing Colour	3.000 mm 10 pz / box E	
	PT To install with PR 300 and PF 300		Length Packing Colour	3.000 mm 10 pz / box E	

03 FOAMED SYSTEM

Nuovo battiscopa completamente schiumato all'interno, facile da installare e senza alcun sportello. Provisto di alette morbide evita il passaggio di acqua e sporco. Ideale per cucine industriali, sale bianche e celle frigo.

New plinth completely foamed inside, easy to install and without flaps. Thanks to its soft fins, no dirt and no water are allowed. Ideal for industrial kitchens, cold rooms and cleanrooms.

Nouveau plinthe à ailettes souples complètement expansé, afin d'éviter le passage d'eau et des bactéries. Facile à installer, parfait pour cuisines industrielles, salles stériles et chambres froides.

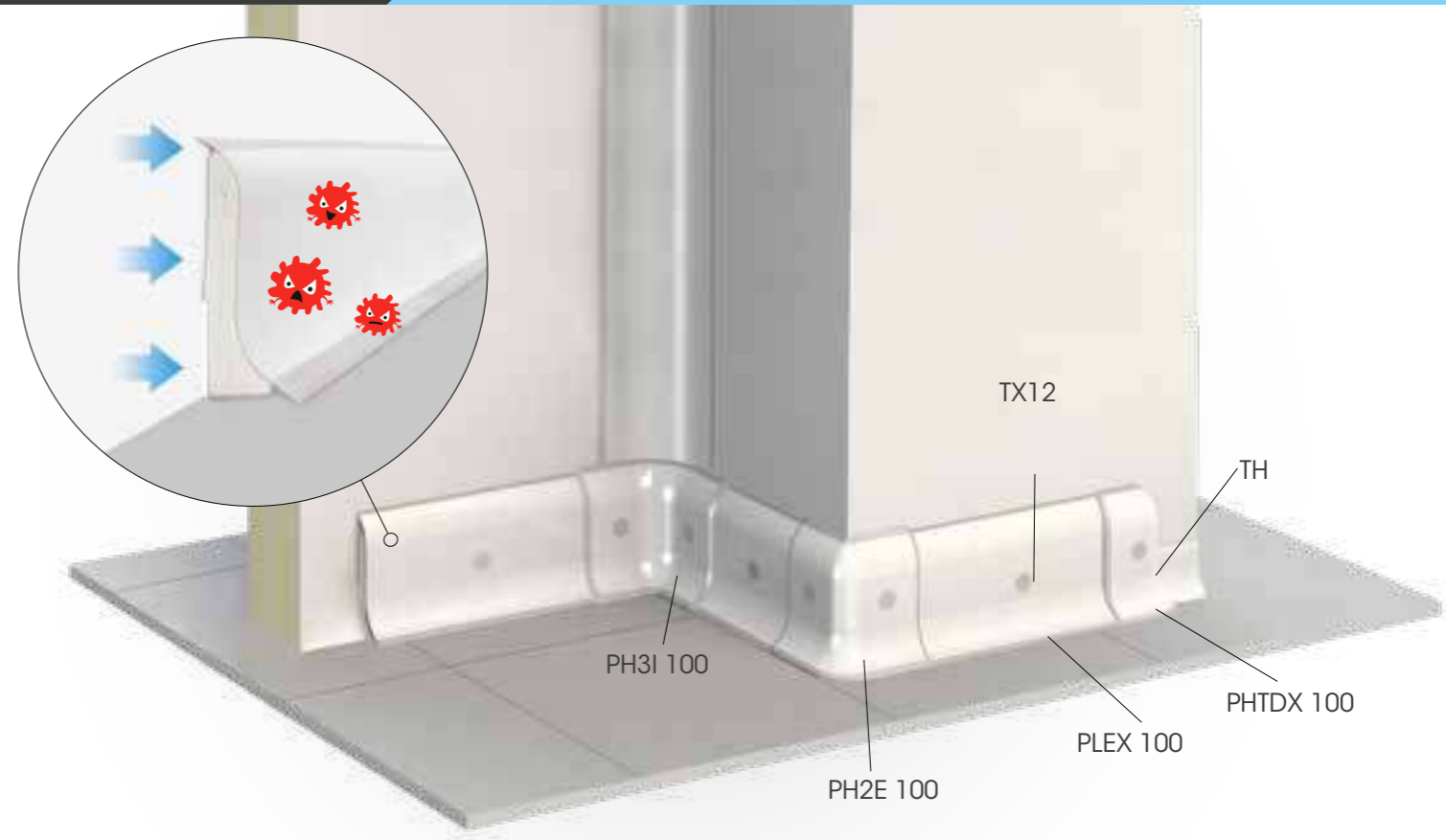

PLEX 100
To install with TX12

Packing 8 pz / box
Lenght 4.000 mm
Colour M E K



PERFORATED



PH2I 100
To install with TH



Packing 50 pz / box
Colour E K



PH3I 100
To install with TH



Packing 50 pz / box
Colour E K



PH2E 100
To install with TH



Packing 50 pz / box
Colour E K



PHTDX 100
PHTSX 100
To install with TH



Packing 100 pz / box
Colour E K

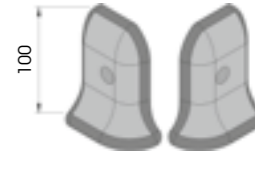

PHJ 100
To install with TH



Packing 100 pz / box
Colour E F K



04

HERMETIC SYSTEM

NEW BI MATERIAL CAPS

NEW CAPS ALSO TO BE USED WITH PL 100

NOUVEAUX EMBOUTS À UTILISER AUSSI AVEC PL 100

NUOVI TAPPI UTILIZZABILI ANCHE CON PL 100

NEW COLOUR STAINLESS STEEL







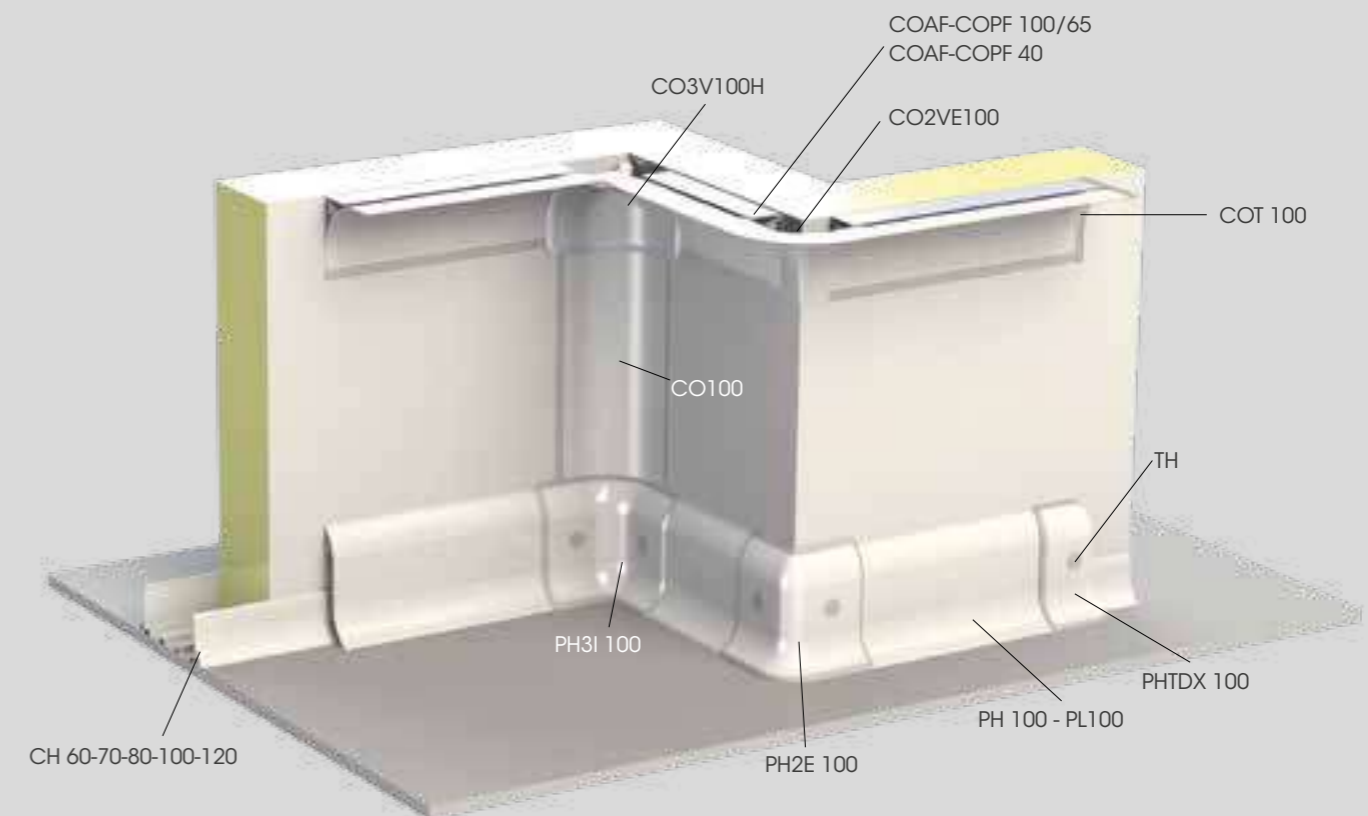



New sanitary system, excellent water and dirty resistant, provided with a new plinth with a large flap to make the installation easier and bi material caps to grant hermetic closing. To be used with standard hygienic corners.

Nuovo sistema profili sanitari con un battiscopa dotato di grande sportello per facilitare l'installazione. Completo di tappi in bimatereale per una chiusura ermetica. Ottima tenuta dell'acqua e dello sporco. Utilizzabile con angoli sanitari standard.

Nouveau système sanitaire, résistant à l'eau et à l'impureté, doté d'une plinthe avec une grande porte pour faciliter l'installation et accessoires injectées en bi matériel pour une fermeture hermétique. À utiliser avec les congés d'angle standards.



	CS 65	Length Packing Colour	4.000 mm 25 pz / box E F	
	CO 65	Length Packing Colour	4.000 mm 25 pz / box E F O	
	CO 100	Length Packing Colour	4.000 mm 25 pz / box E F O	
	CSP with holes CSA	Material Length Packing	CSP plastic CSA aluminium 4000 mm CSP 25 pz / box CSA 25 pz / bundle	
	COPF 100-65 with holes COAF 100-65	Material Length Packing	COPF plastic COAF aluminium 4.000 mm COPF 100-65 25 pz / box COAF 100-65 25 pz / bundle	
	COPF 40 with holes COAF 40	Material Length Packing	COPF plastic COAF aluminium 4.000 mm COPF 40 25 pz / box COAF 40 25 pz / bundle	
	CP 100	Length Packing Colour	4.000 mm 10 pz / box B E F M	
	CPF 100	Material Length Packing	plastic 4.000 mm 10 pz / bag	
	CPT 100	Packing Colour	40 pz / box B E F	
	PH 100	Length Packing Colour	4.000 mm 12 pz / box E F	

	CO3V 65	Packing Colour	100 pz / box E F O	
	CO3V 100 H To install with TH	BI MATERIAL CAP Packing Colour	100 pz / box E F	
	CO2VE 65	Packing Colour	100 pz / box E F O	
	CO2VE 100	NEW DESIGN Packing Colour	100 pz / box E	
	CO2VI 65	NEW Packing Colour	100 pz / box E	
	COT 65 COT 100	Packing Colour	100 pz / box E F O	
	PH2I 100 To install with TH	BI MATERIAL CAP Packing Colour	50 pz / box E F	
	PH3I 100 To install with TH	BI MATERIAL CAP Packing Colour	50 pz / box E F	
	PH2E 100 To install with TH	BI MATERIAL CAP Packing Colour	50 pz / box E F	
	PHTDX 100 PHTSX 100 To install with TH	BI MATERIAL CAP Packing Colour	100 pz / box E F	
	PHJ 100 To install with TH	BI MATERIAL CAP Packing Colour	100 pz / box E F K	

05

STANDARD SYSTEM

NEW
COLOUR
STAINLESS
STEEL

Basic hygienic corner with aluminium or pvc guide, with soft fins to fix it to the wall to assure hygiene. It can be used with plinth.

Angolo sanitario classico con supporto in alluminio o pvc. Provisto di alette morbide per assicurare il fissaggio alle pareti ed evitare il passaggio dello sporco. Perfetta combinazione con il battiscopa a pavimento.

Système d'angle standard hygiénique avec un support en aluminium ou en pvc. Dispose d'ailettes souples assurant une adhésion aux murs afin d'éviter le passage de la poussière. Peut-être utilisé avec des plinthes.





CS 45

Length **4.000 mm**
Packing **50 pz / box**
Colour **E F**

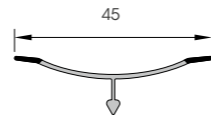

CO 65

Length **4.000 mm**
Packing **25 pz / box**
Colour **E F O**

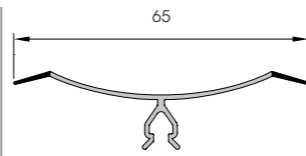

CO 100

Length **4.000 mm**
Packing **25 pz / box**
Colour **E F O**

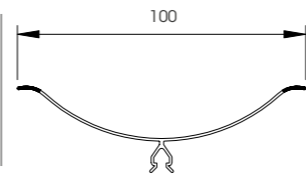

CSP 45

Length **4.000 mm**
Packing **50 pz / box**

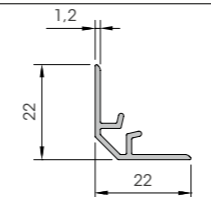

COPF 100-65 with holes
COAF 100-65

Material **COPF plastic**
COAF aluminium
Length **4.000 mm**
Packing **COPF 100-65**
25 pz / box
COAF 100-65
25 pz / bundle

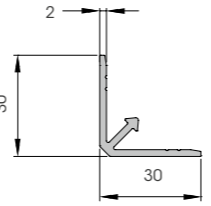

COPF 40 with holes
COAF 40

Material **COPF plastic**
COAF aluminium
Length **4.000 mm**
Packing **COPF 40**
25 pz / box
COAF 40
25 pz / bundle

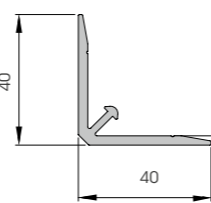

CP 100

Length **4.000 mm**
Packing **10 pz / box**
Colour **B E F M**



CPF 100

Material **plastic**
Length **4.000 mm**
Packing **10 pz / bag**



CPT 100

Packing **40 pz / box**
Colour **B E F**

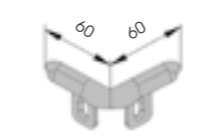

PL 100 R

Length **4.000 mm**
Packing **10 pz / box**
Colour **E F**

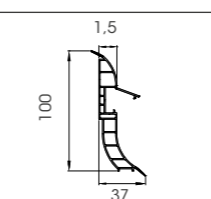

CO3V 45

To install with TM5

Packing **100 pz / box**
Colour **E**

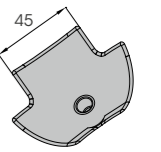

CO3V 65
CO3V 100

Packing **100 pz / box**
Colour **E F O**

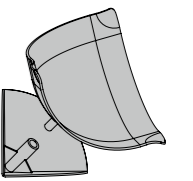

CO2VE 65

CO2VE 100

NEW DESIGN

Packing **100 pz / box**
Colour **E F O**

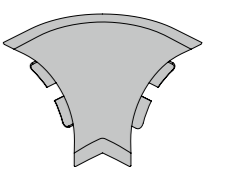

CO2VI 65

NEW

Packing **100 pz / box**
Colour **E**

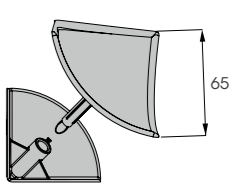

COT 65
COT 100

Packing **100 pz / box**
Colour **E F O**



PL2I 100
PL3I 100

Packing **50 pz / box**
Colour **E F**

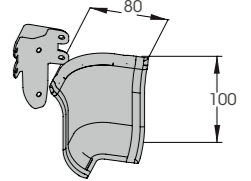

PHJ 100

To install with TH

BI MATERIAL CAP

Packing **100 pz / box**
Colour **E F K**



PL2E 100

Packing **50 pz / box**
Colour **E F**

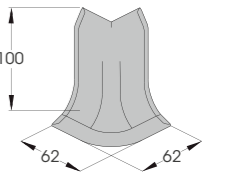

PLTDX 100
PLTSX 100

Packing **100 pz / box**
Colour **E F**

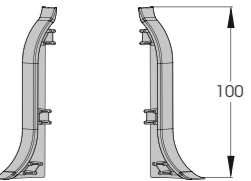

06

SPEED SYSTEM

Hygienic corner system rapid and easy to install, available with fixing buttons on the ending caps which eliminate the need for the wall drilling.

Linea d'angolo sanitario rapida e facile da installare che elimina la foratura alle pareti sostituita da bottoni di supporto ai terminali.

Congé d'angle sanitaire facile à l'installation qui permet d'éviter la perforation de murs grâce à des embouts à pression insérés dans les espaces préforés.

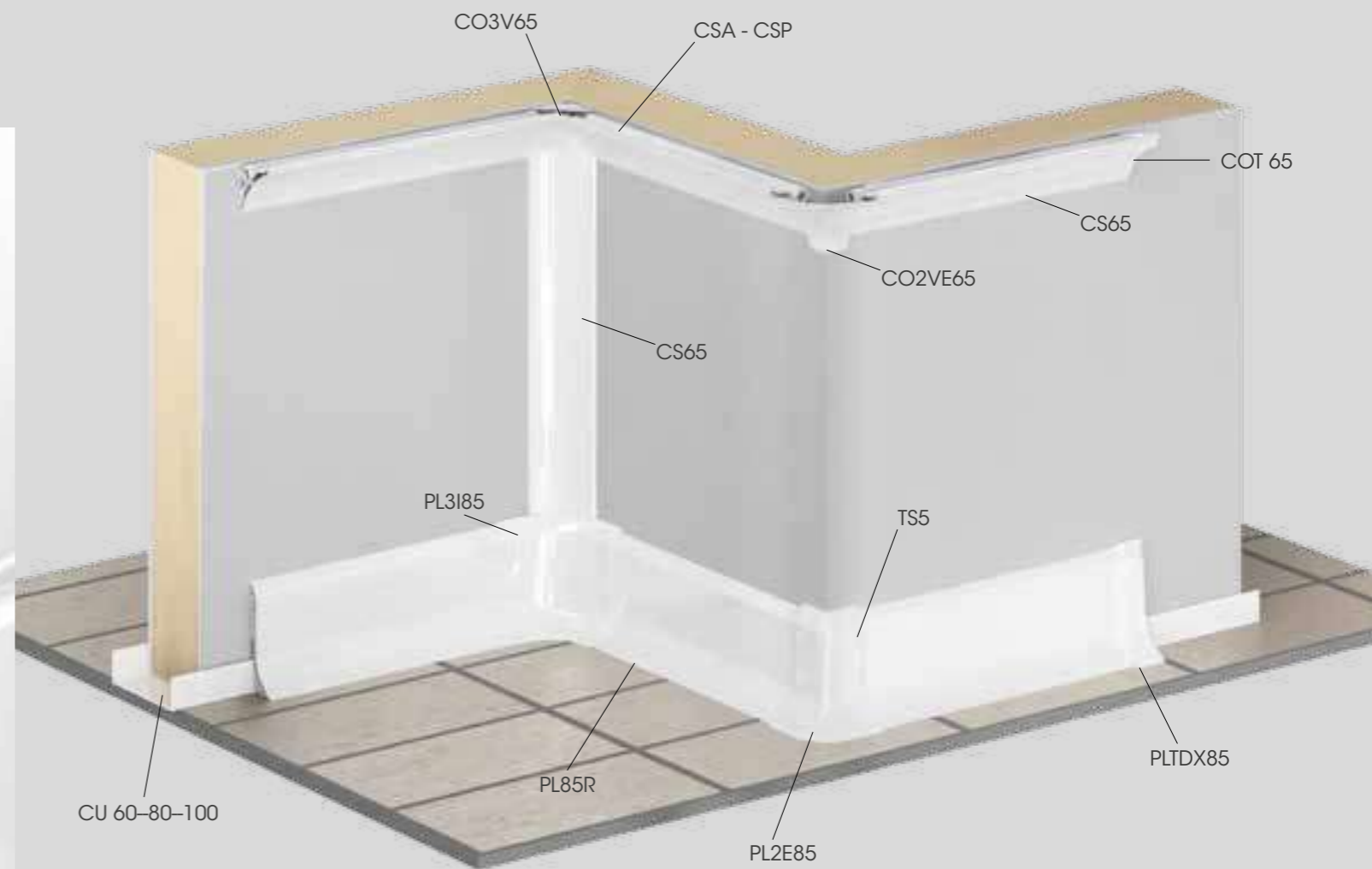



CS 65

Length **4.000 mm**
Packing **25 pz / box**
Colour **E F**

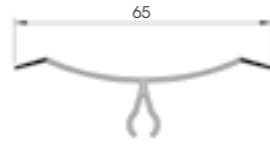

CSP with holes
CSA

Material **CSP plastic**
CSA aluminium
Length **4.000 mm**
Packing **CSP**
25 pz / box
CSA
25 pz / bundle

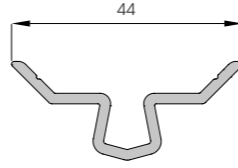

CP 100

Length **4.000 mm**
Packing **10 pz / box**
Colour **B E F M**

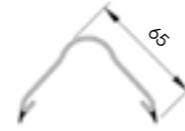

CPF 100

Material **plastic**
Length **4.000 mm**
Packing **10 pz / bag**



CPT 100

Packing **40 pz / box**
Colour **B E F**

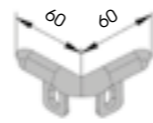

PL 85 R

Length **4.000 mm**
Packing **15 pz / box**
Colour **E F**

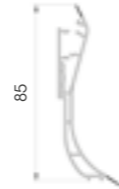

PL2I 85 with holes
PL2I 85 NH without holes

To install with TS5

Packing **50 pz / box**
Colour **E F**

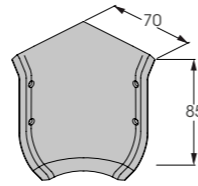

PL3I 85 with holes
PL3I 85 NH without holes

To install with TS5

Packing **50 pz / box**
Colour **E F**

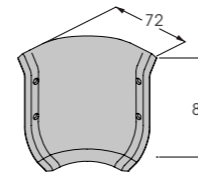

PL2E 85 with holes
PL2E 85 NH without holes

To install with TS5

Packing **50 pz / box**
Colour **E F**

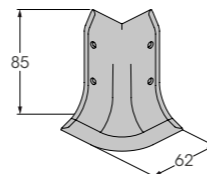

PLTDX 85 with holes
PLTSX 85 with holes
PLTDX 85 NH without holes
PLTSX 85 NH without holes
To install with TS5

Packing **100 pz / box**
Colour **E F**

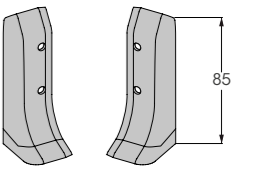

07

MODULAR SYSTEM

Complete system with the possibility to change the size of profiles and internal caps which suit all the solutions. Warranty and easy way to fix it. Hidden screws.

Sistema completo con possibilità di allungamento modulare dei profili e raccordi interni che si adattano a tutte le combinazioni. Garanzia e facilità di fissaggio. Viti a scomparsa.

Système modulable complet avec la possibilité de modifier la taille des profilés et des raccords internes, qui s'adapte alors à toutes les solutions. Solidité garantie et facile à fixer. Vis dissimulées.

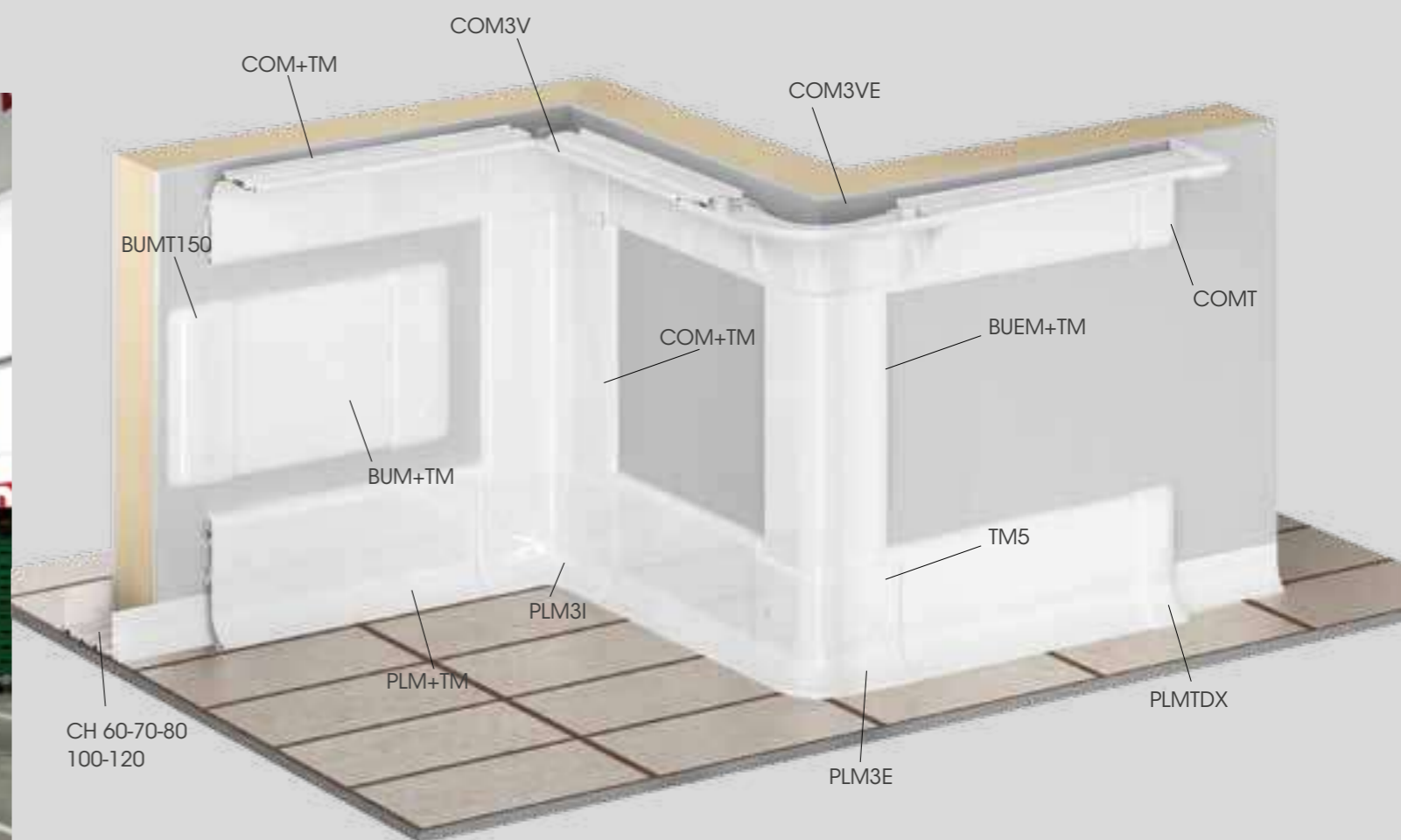



TM

Length **4.000 mm**
Packing **40 pz / box**
Colour **B E**

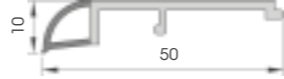

EXM

Length **4.000 mm**
Packing **20 pz / box**
Colour **B E**

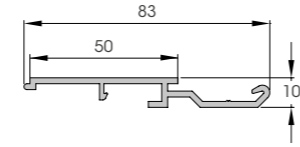

PLM

Length **4.000 mm**
Packing **10 pz / box**
Colour **B E**

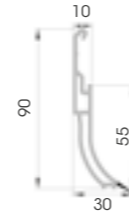

COM

Length **4.000 mm**
Packing **10 pz / box**
Colour **B E**

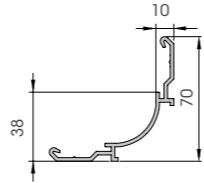

BUEM

Length **4.000 mm**
Packing **10 pz / box**
Colour **B E**

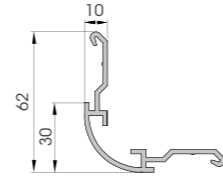

BUM

Length **4.000 mm**
Packing **8 pz / box**
Colour **A B E G H M**

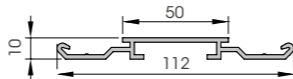

PLM3I

To install with TM5

Packing **50 pz / box**
Colour **B E**

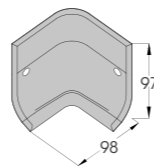

PLM3E

To install with TM5

Packing **50 pz / box**
Colour **B E**

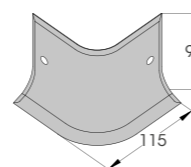

PLMT DX
PLMT SX

To install with TM5

Packing **100 pz / box**
Colour **B E**

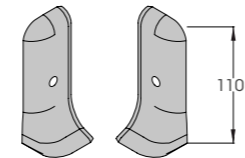

COM3 V

To install with TM5

Packing **50 pz / box**
Colour **B E**

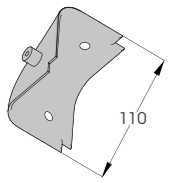

COM3 VE

To install with TM5

Packing **25 pz / box**
Colour **B E**

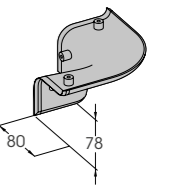

COMT

To install with TM5

Packing **50 pz / box**
Colour **B E**

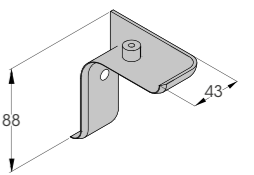

BUMT 150

To install with TM5

Packing **50 pz / box**
Colour **B E**

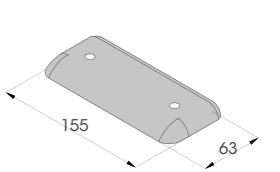

BUMT 250

To install with TS7

Packing **25 pz / box**
Colour **E**

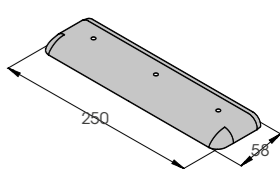

PLN3I 100

To install with TM5

Packing **50 pz / box**
Colour **B E**

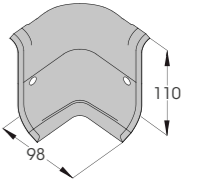

PLN2E 100

To install with TM5

Packing **50 pz / box**
Colour **B E**

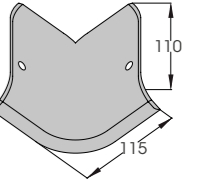

08 CHANNELS

**OUR CHANNELS
FIT FOR ALL OUR
PLINTHS**

Different sizes available with rounded sides and soft fins for a good fit to the floor. Cheap models available, see CU.

Ampia scelta tra canale grecate con bordi arrotondati e alette morbide per assicurare maggiore tenuta. Disponibili anche in versione più economica, vedi CU.

Plusieurs dimensions sont disponibles, nervurées avec des bords arrondis et des ailettes souples pour permettre une meilleure adhésion au sol. Différents modèles économiques disponibles, voir CU.

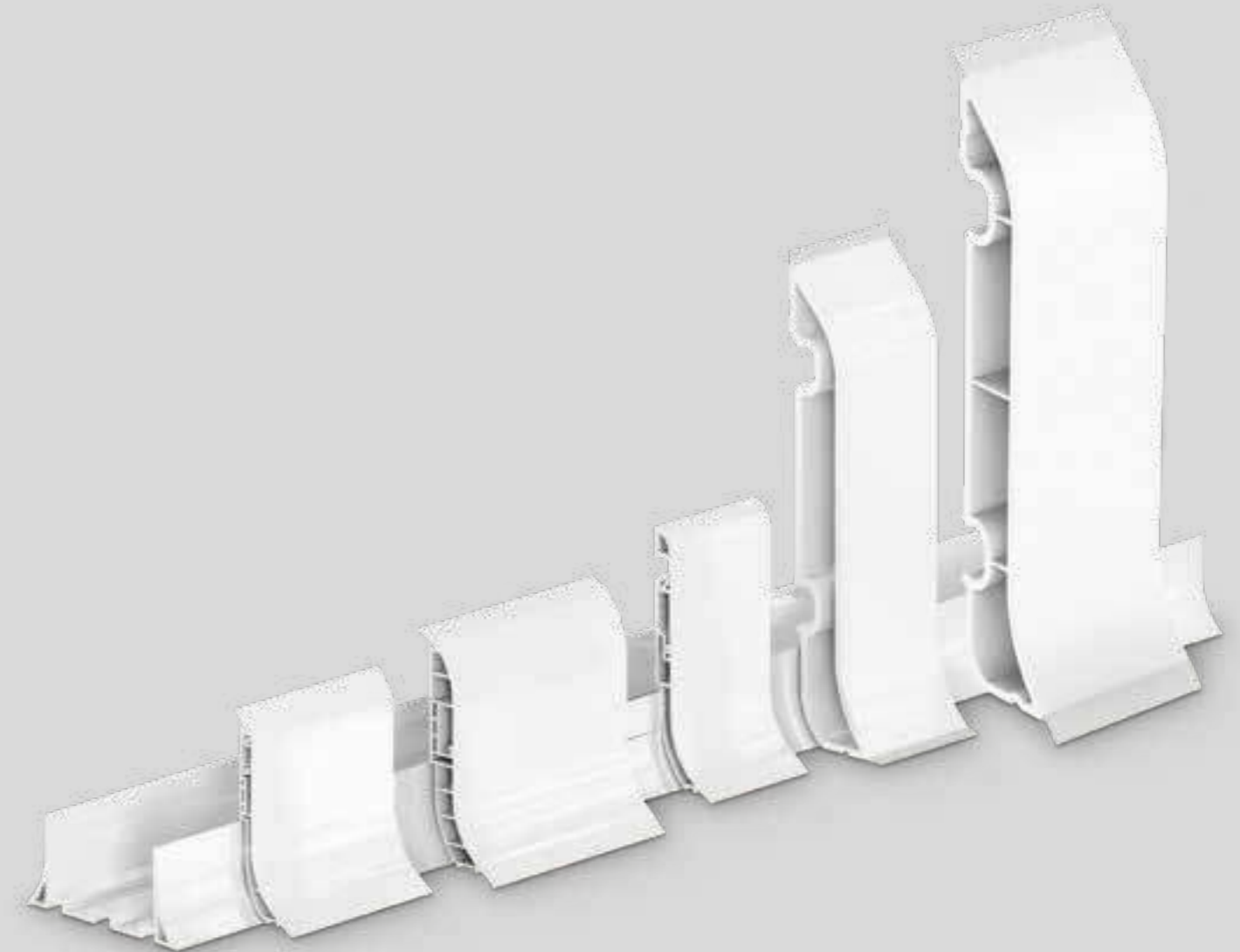



CH 60

Length **4.000 mm**
Packing **2 pz / bundle**
Colour **E F**

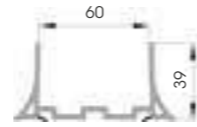

CH 70

Length **4.000 mm**
Packing **2 pz / bundle**
Colour **E F**

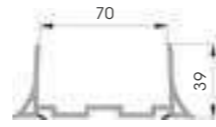

CH 80

Length **4.000 mm**
Packing **2 pz / bundle**
Colour **E F**

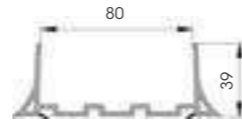

CH 100

Length **4.000 mm**
Packing **2 pz / bundle**
Colour **E F**

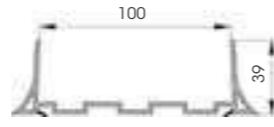

CH 120

Length **4.000 mm**
Packing **2 pz / bundle**
Colour **E F**



CU 40

Length **4.000 mm**
Packing **8 pz / bag**
Colour **E F**

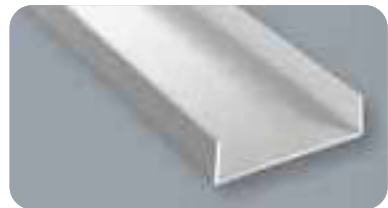
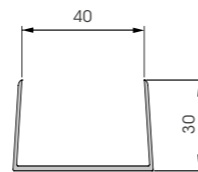

CU 60

Length **4.000 mm**
Packing **4 pz / bundle**
Colour **E F**

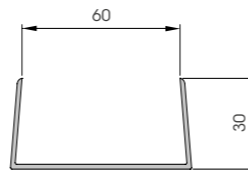

CU 80

Length **4.000 m**
Packing **4 pz / bundle**
Colour **E F**

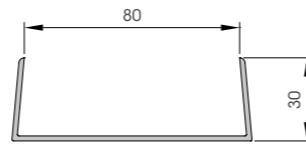

CU 100

Length **4.000 mm**
Packing **4 pz / bundle**
Colour **E F**

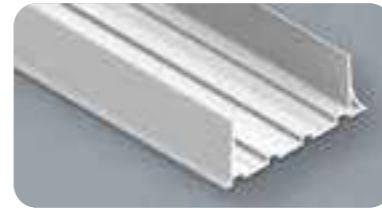
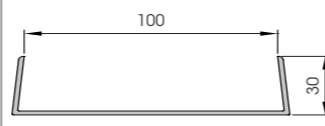

CL 80

Length **4.000 mm**
Packing **8 pz / box**
Colour **E F**

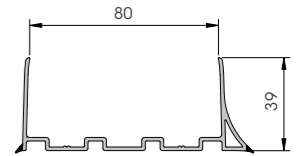

CHA 80

Packing **24 pz / box**
Colour **E F**



CHA 100

Packing **48 pz / box**
Colour **E F**

CHA 60 R 15
CHA 80 R 15

Packing **24 pz / box**
Colour **E F**

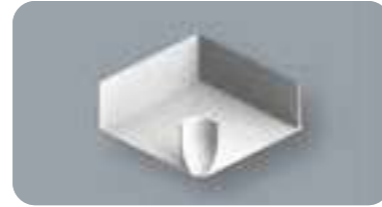

CHA 100 R 15

Packing **48 pz / box**
Colour **E F**

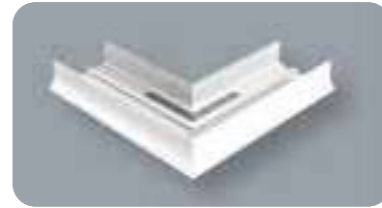

CLA 80 R 13

To install with
CL 80

Packing **24 pz / box**
Colour **E F**

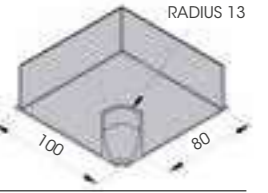

CHL 60
CHL 70
CHL 120

Packing **to be defined**
Colour **E F**

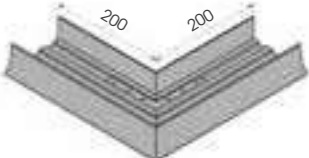

CHT 60
CHT 70
CHT 80
CHT 100
CHT 120

Packing **to be defined**
Colour **E F**

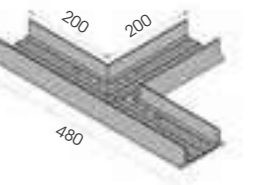

09

FIXER SYSTEM

New and useful system for quick assembly of cold rooms or other buildings using continuous panels.

Innovativo sistema rapido e funzionale per il montaggio di celle frigo o altre strutture a partire da pannelli in continuo.

Système nouveau, rapide et fonctionnel pour l'assemblage de chambres froides ou autres structures à partir de panneaux en continu.

NEW

**ADL / ADLC
TO COMPLETE
THE PROJECT**



**QUICK
AND EASY
FIXING BY
RIVETS**

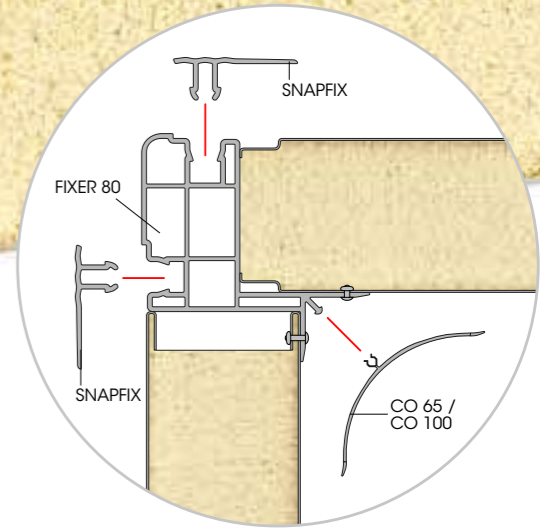

FIXER 80

Length **5.800 mm**
On request
Packing **2 pz / box**
Colour **K**

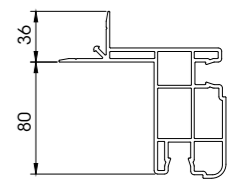

FIXER 100

Length **5.800 mm**
On request
Packing **2 pz / box**
Colour **K**

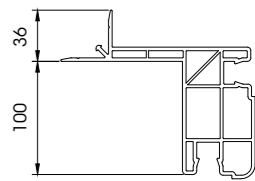

SNAPFIX

To install with
FIXER 80 and FIXER 100

Length **5.800 mm**
On request
Packing **4 pz / box**
Colour **K**

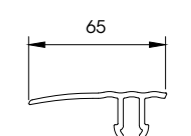

**FIT 80 DX
FIT 80 SX**

Packing **4 pz / box**
Colour **K**

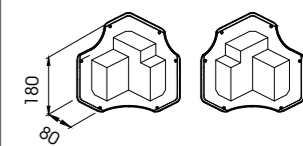

**FIT 100 DX
FIT 100 SX**

Packing **4 pz / box**
Colour **K**

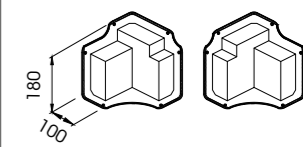

NEW SYSTEM = MORE BENEFITS !

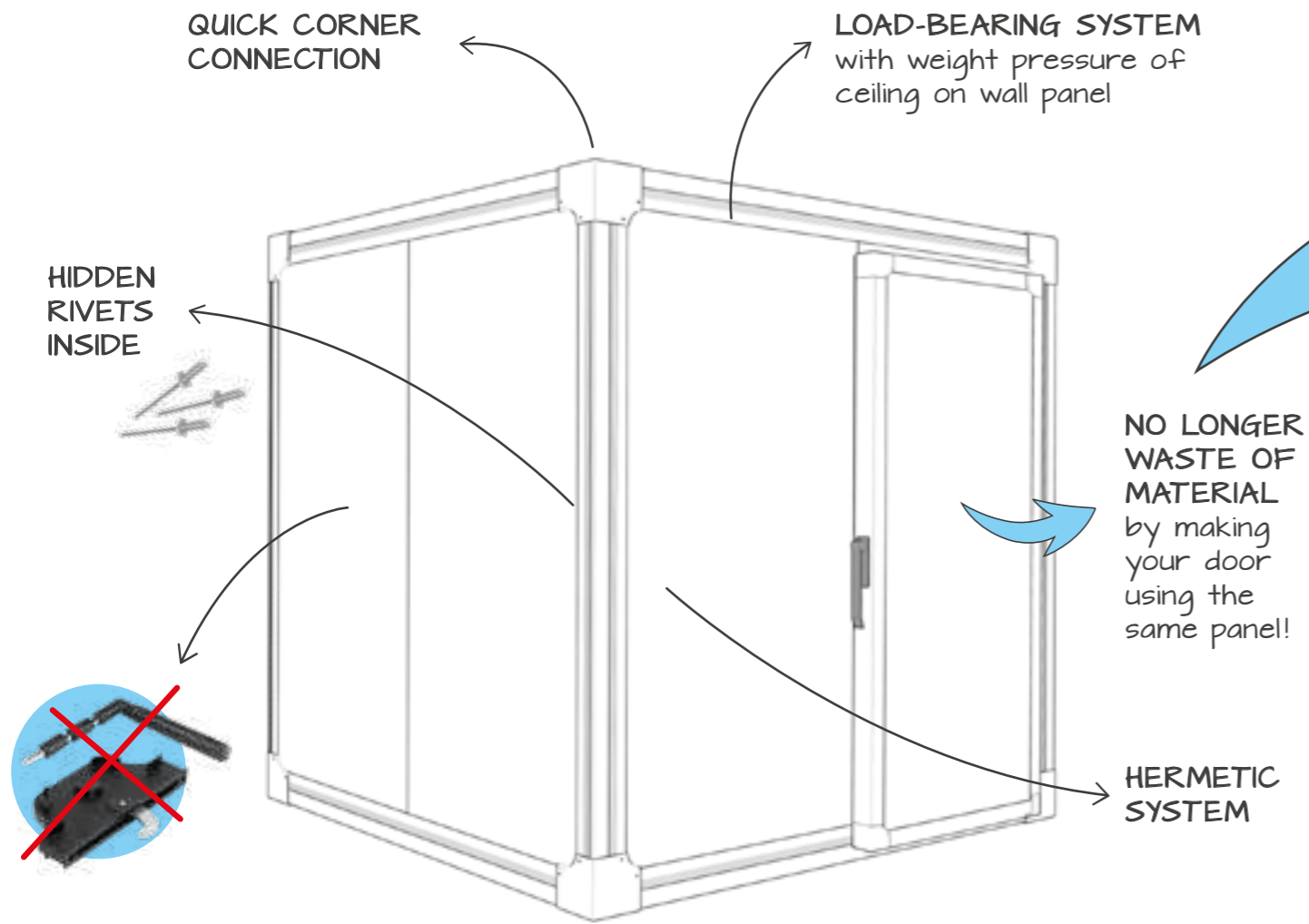

ADL CORNER

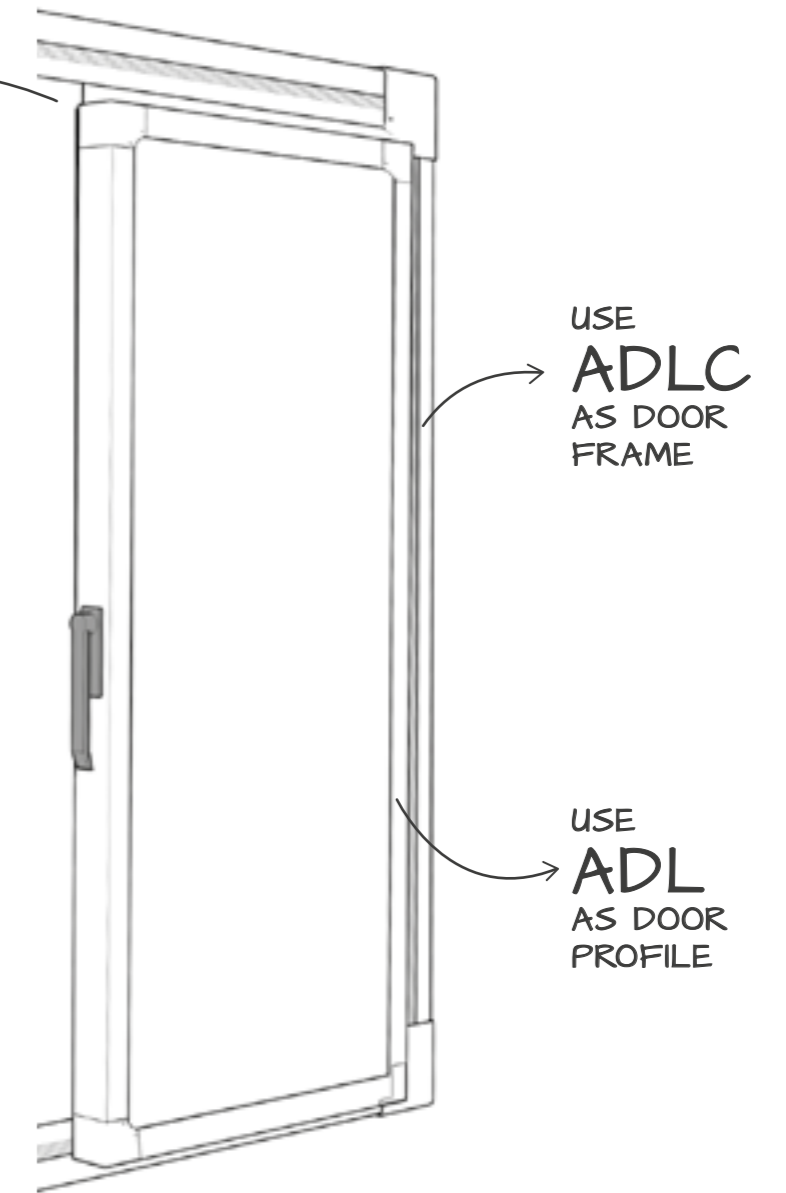
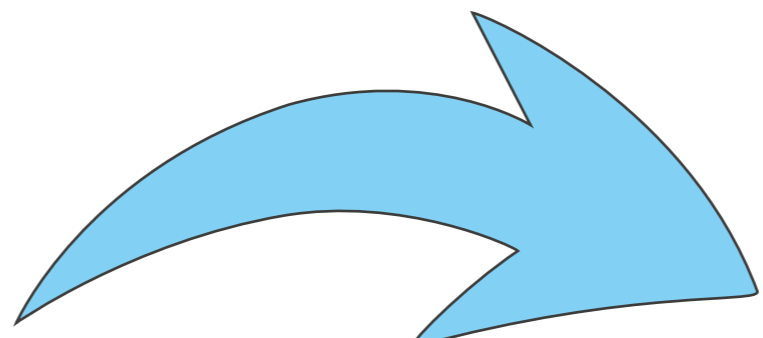

A REAL REVOLUTION
You can now use CONTINUOUS PANELS

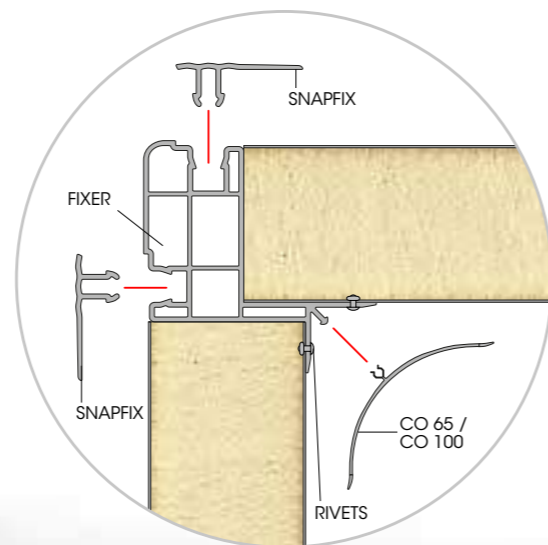

SAVE TIME AND MONEY



Save time with our quick and easy fixing



Save money with our new modular system



10 PILLAR SYSTEM

Cheap and useful system studied for quick planning and installation of cold rooms. Perfect isolation, equipped with an internal rounded corner for easy cleaning.

Sistema economico e funzionale ideato per la rapida progettazione e gestione delle celle frigorifere. Ottimo isolamento, accessorizzato con angoli arrotondati all'interno per facilitare la pulizia.

Système pratique et économique étudié pour la réalisation et la gestion de chambres froides. Isolation parfaite, équipé d'angles arrondis à l'intérieur pour faciliter le nettoyage.

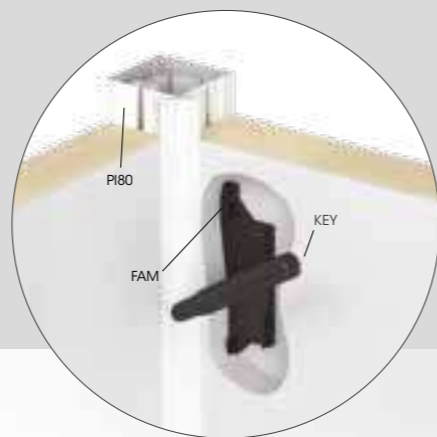

Pillar System

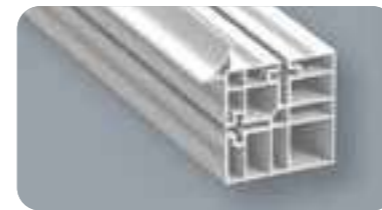

PIT 80

Length **5.000 mm**
Packing **unpacked on pallet**
Colour **E**

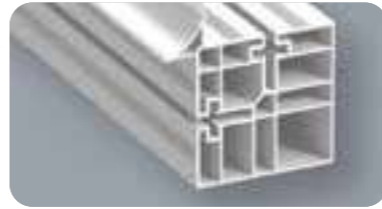
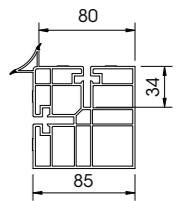

PIT 120

Length **5.000 mm**
Packing **unpacked on pallet**
Colour **E**

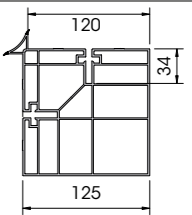

GE

Material **Steel**
Length **5.000 mm**
Packing **10 pz / bundle**



FAM

Packing **200 pz / box**
Colour **D**

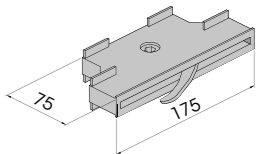

FAF

Packing **200 pz / box**
Colour **D**

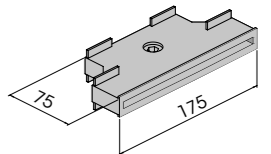

KEY

Packing **100 pz / box**
Colour **D**

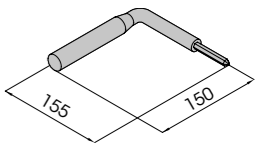

PIC 80

Packing **8 pz / box**
Colour **E**

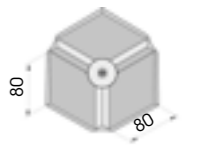

PIC 120

Packing **4 pz / box**
Colour **E**

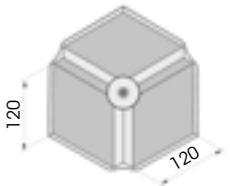

11 KERB

To install with Channels CH and CU
Monta con canale CH e CU
À installer avec les U de sol CH et CU



A large size protection system,
ideal for walls and panels.
Easy to install and clean.
Fully equipped with corner
caps and buttons.

Sistema di protezione di grandi
dimensioni, ideale per muri e
pannelli. Facile da installare e pulire.
Completo di angolari e tappi.

Système de protection de grands
dimensions, idéal pour les murs et
les panneaux. Facile à installer et
à nettoyer. Complété de bouchons
d'angles et d'embouts.

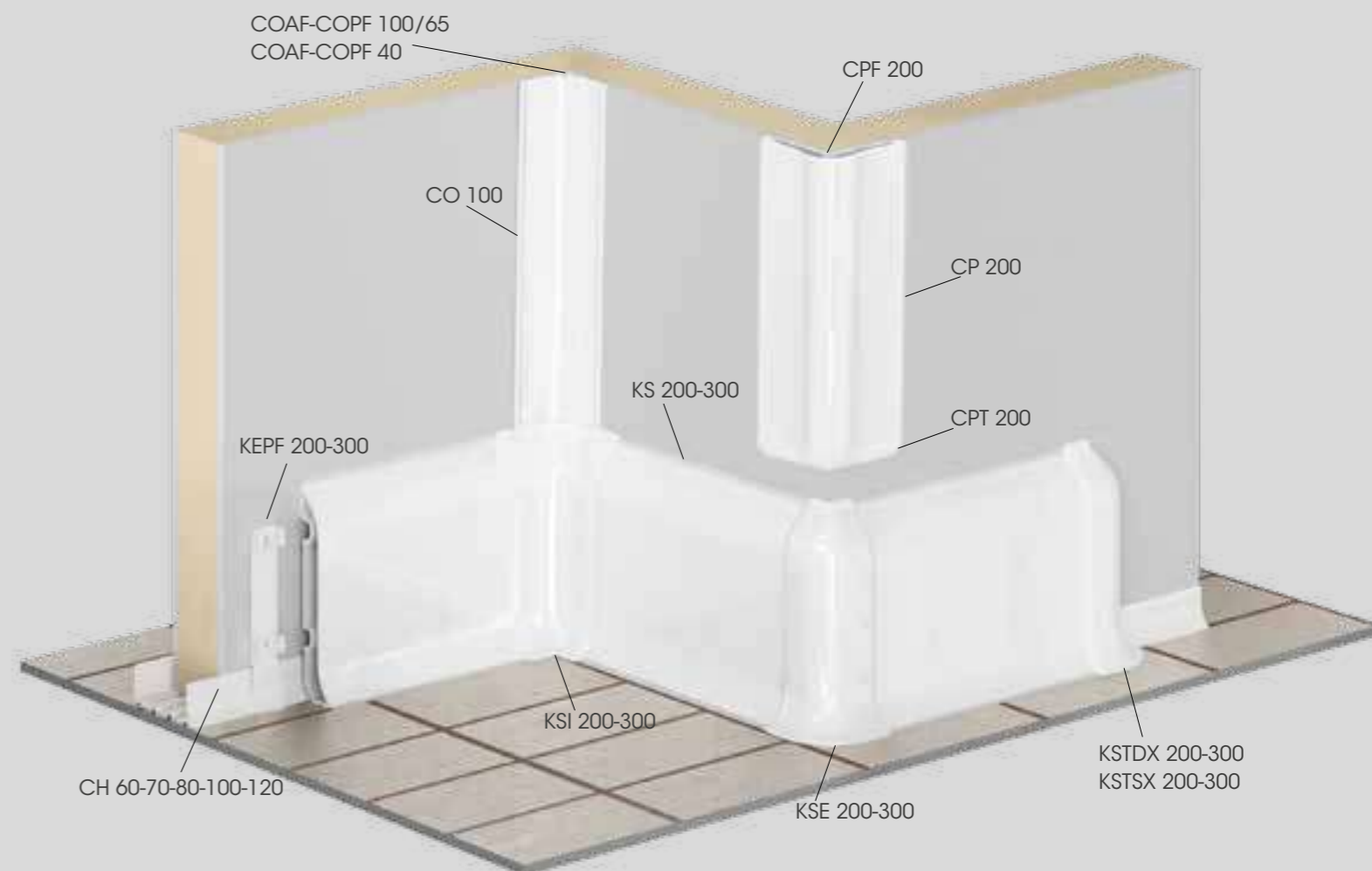



KS 200

Length **4.000 mm**
Packing **3 pz / box**
Colour **B E M**

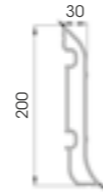

KEPF 200

To install with TB14

Packing **50 pz / box**
Colour **K**

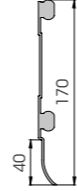

KSJ 200

To install with TB14 / TF14

Packing **20 pz / box**
Colour **B E**

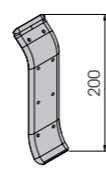

KSI 200

To install with TB14 / TF14

Packing **20 pz / box**
Colour **B E**

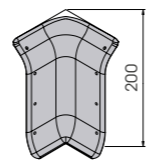

KSE 200

To install with TB14 / TF14

Packing **20 pz / box**
Colour **B E**

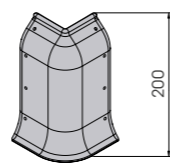

KSTDX 200
KSTSX 200

To install with TB14 / TF14

Packing **20 pz / box**
Colour **B E**

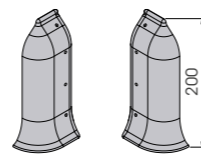

KSJ 200 LT



Packing **20 pz / box**
Colour **K**

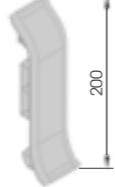

FLEXIBLE JOINT



CP 200

Length **4.000 mm**
Packing **2 pz / bag**
Colour **B E M**



CPF 200

Length **4.000 mm**
Packing **2 pz / bag**



CPT 200

Packing **20 pz / box**
Colour **B E**



KS 300

Length **4.000 mm**
Packing **1 pz**
Colour **E M**

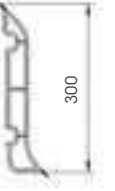

KEPF 300

To install with TB20

Packing **40 pz / box**
Colour **K**

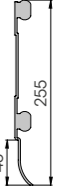

KSJ 300

To install with TB20 / TF20

Packing **10 pz / box**
Colour **B E**

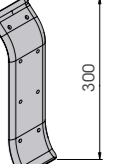

KSI 300

To install with TB20 / TF20

Packing **10 pz / box**
Colour **B E**

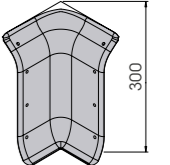

KSE 300

To install with TB20 / TF20

Packing **10 pz / box**
Colour **B E**

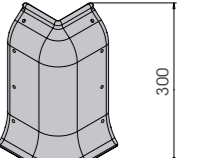

KSTDX 300
KSTSX 300

To install with TB20 / TF20

Packing **10 pz / box**
Colour **B E**

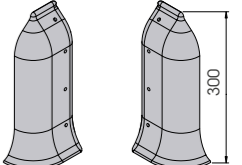

12 ANTISHOCK SYSTEM

New bumper and plinth system produced in soft material, could be used in cold rooms, refrigerated storages and garages. Thanks to material elasticity, it features good anti-shock property.

Nuova linea di paracolpi e battiscopa in materiale morbido per celle frigo, magazzini refrigerati, garage. Ottima proprietà anti-urto grazie all'elasticità del materiale utilizzato.

Nouvelle gamme de lisses de protection et plinthes en matière souple pour les chambres froides, depots et garages. Excellente propriété anti-choc grâce à l'élasticité du matériel utilisé.



Antishock System

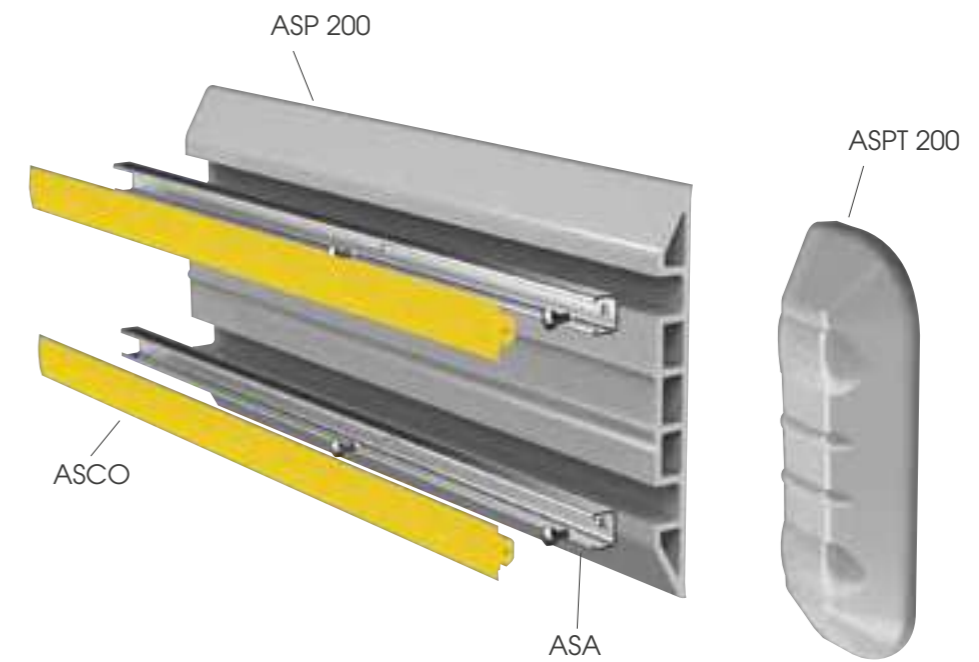

ASP 200



Packing 2 pz / box
L = 4.000 mm
Colour B M



ASPT 200



Packing 10 pz / box
Colour B D

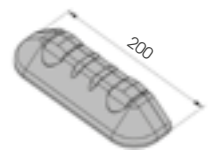

ASA

Material aluminium
Length 4.000 mm
Packing 8 pz / bundle



ASCO



Packing 2 pz / box
L = 32.000 mm
Colour A B D G M



13 DOOR FRAME

Modular system which suits different sizes and thicknesses with the possibility to build corners welding or inserting fast connections. It's equipped with spaces for resistance and for additional supports to add during the assembly. It can be covered with plates.

Sistema modulare adeguabile a differenti spessori con possibilità di effettuare angoli a saldatura o con innesti rapidi. Provvisto di passaggio per resistenza e di insenature per l'inserimento di rinforzi durante il montaggio degli accessori. Rivestibile con lamiera.

Système modulable qui s'adapte à différentes épaisseurs et dimensions, avec la possibilité de réaliser des angles à souder ou avec des connexions rapides. Equipé d'espaces pour le passage de résistances et de renforcements additionnels pour le montage des accessoires. Peut-être revêtu des tôles.

Door Frame

ROUNDED VERSION

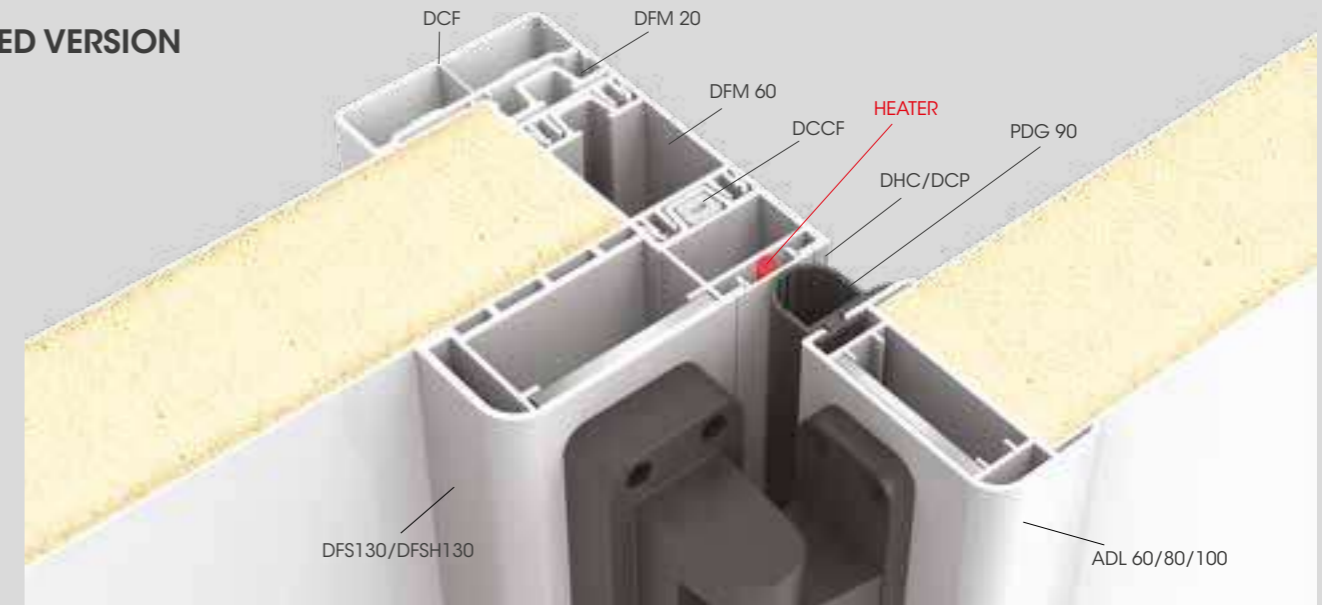

TRIS VERSION

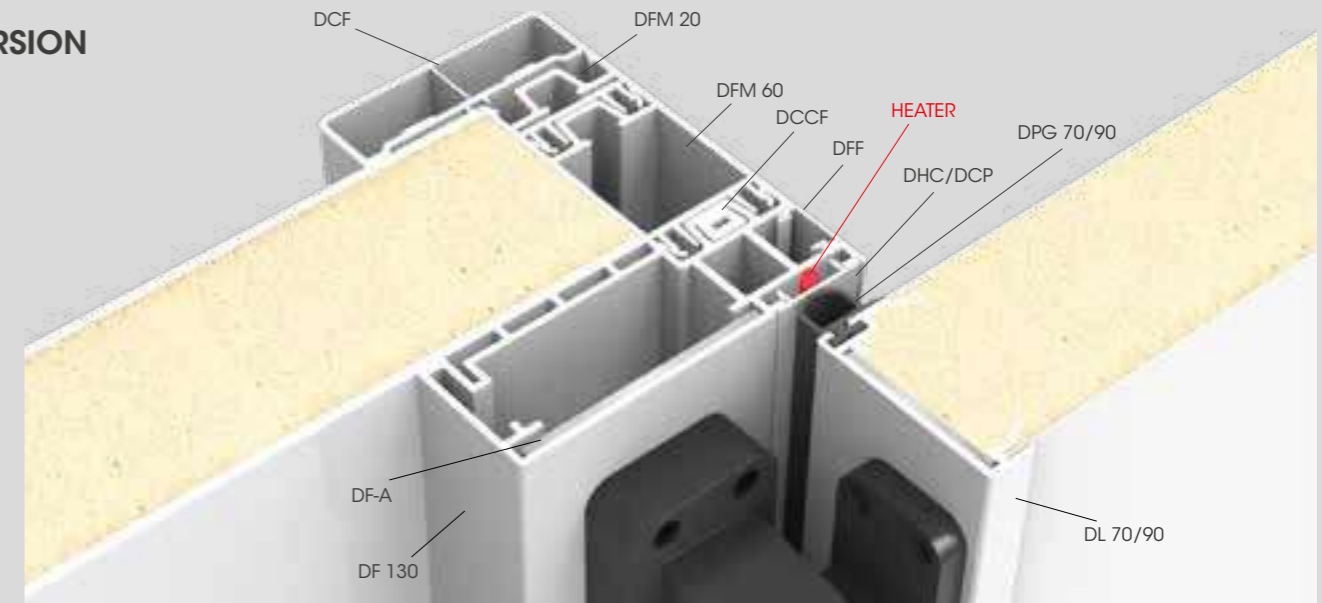

BIS VERSION

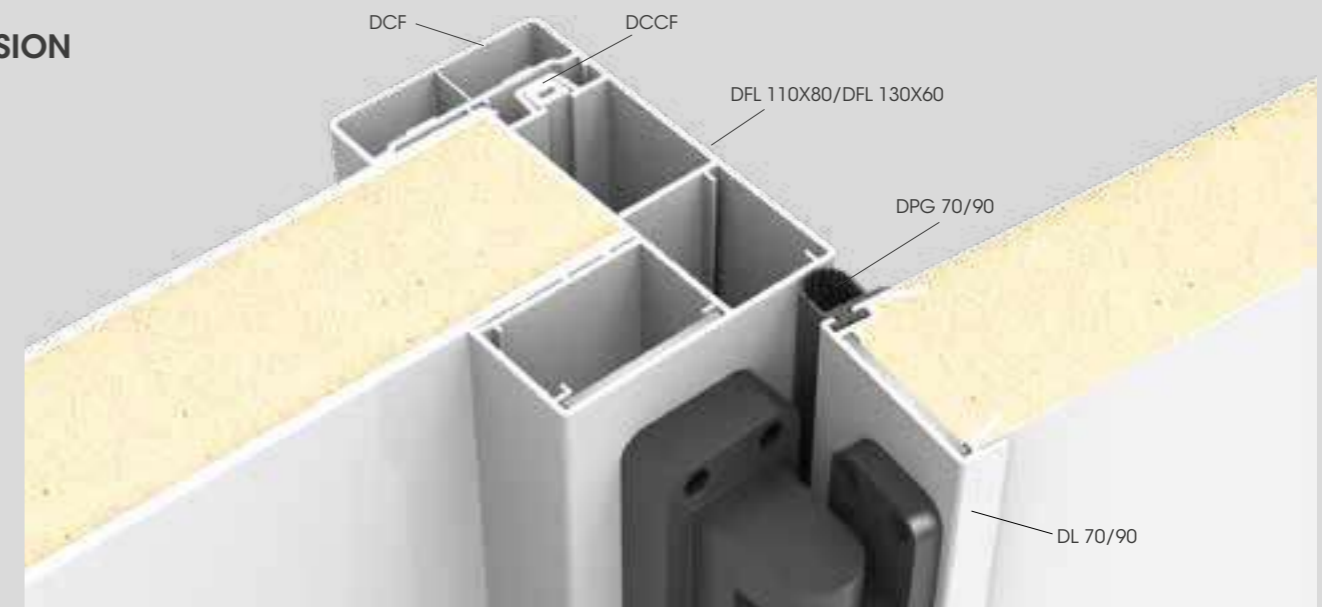

How to assemble DFS 130

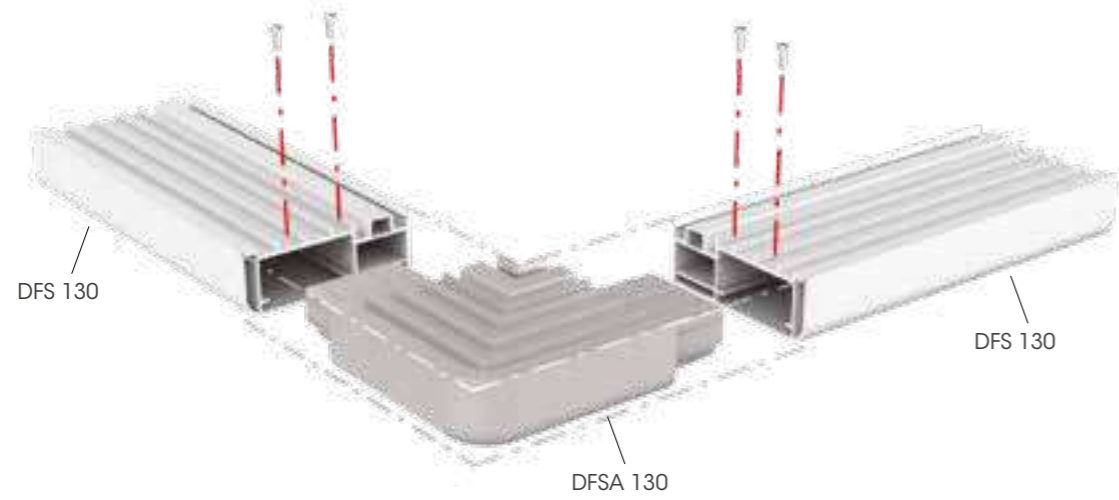

How to assemble DF 130

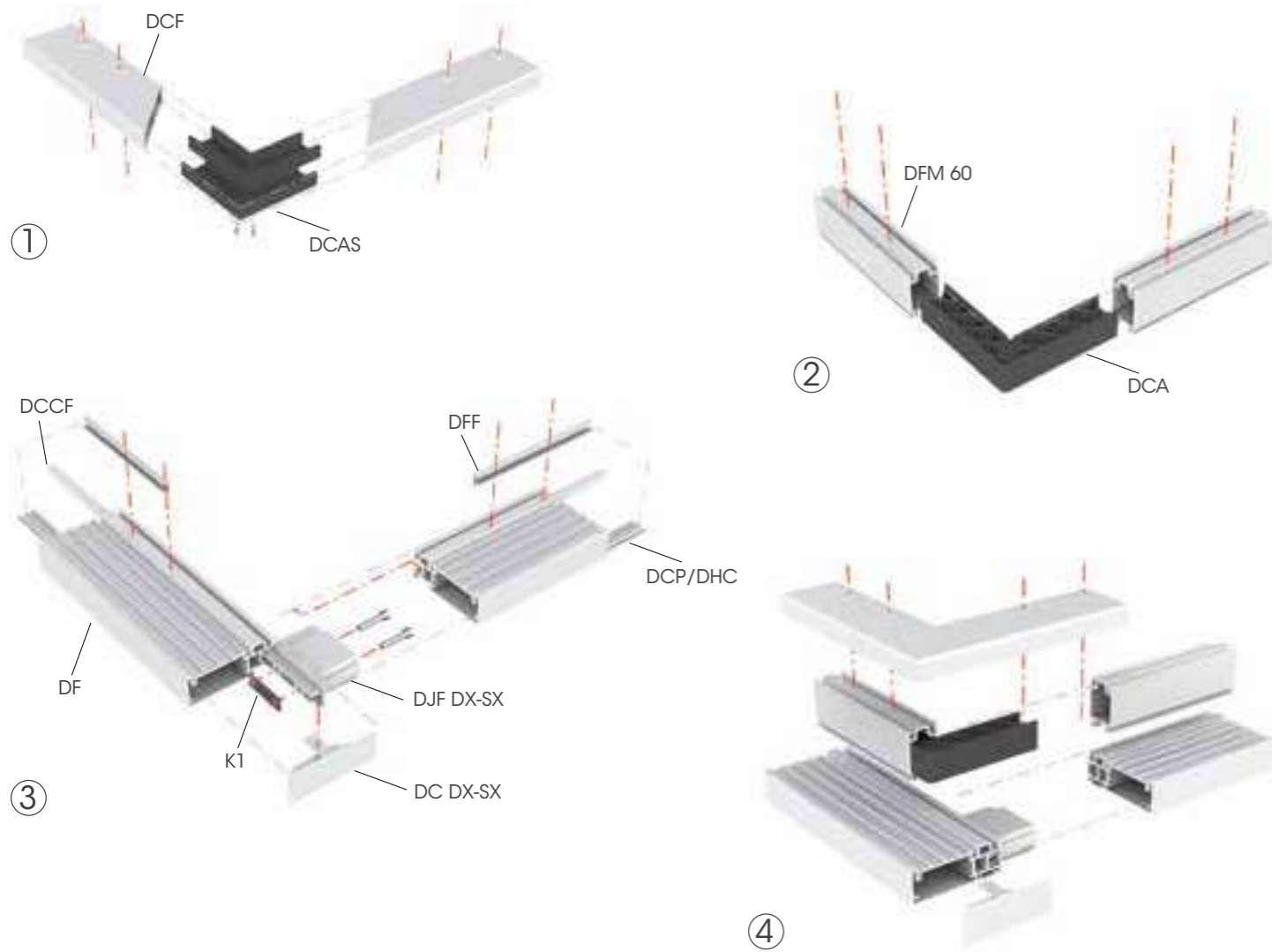

DFS 130

Length **5.800 mm**
Packing **2 pz / bag**
Colour **E**

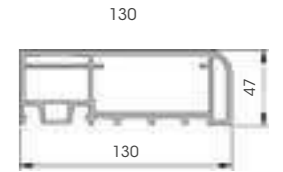

DFS H 130



Length **5.800 mm**
Packing **2 pz / bag**
Colour **E**

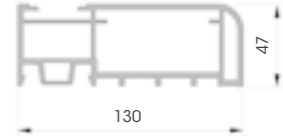

DFSA 130

To install with **DFS 130 and DFS H 130**

Packing **12 pz / bag**
Colour **E K**

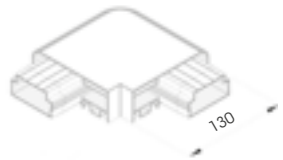

DFC 130



Length **5.800 mm**
Packing **2 pz / bag**
Colour **E**

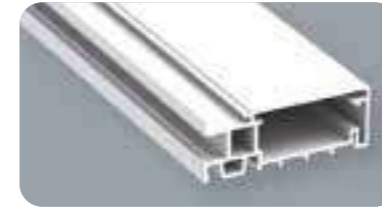
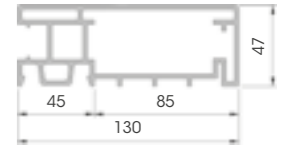

DF 130

Length **5.800 mm**
Packing **2 pz / bag**
Colour **E**

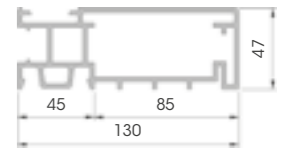

**ADLC 60
ADLC 80
ADLC 100**

Length **5.800 mm**
Packing **2 pz / bag**
Colour **E K**

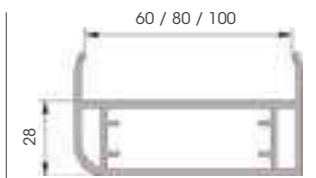

**ADL H 60
ADL H 80
ADL H 100**



Length **5.800 mm**
Packing **2 pz / bag**
Colour **E K**

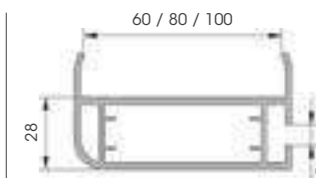

AHC

To install with **ADL H 60/80/100**

Material **aluminium**
Length **5.800 mm**
Packing **25 pz / bag**

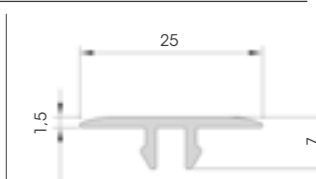

DFL 110x80

Length **5.800 mm**
Packing **2 pz / bag**
Colour **E**

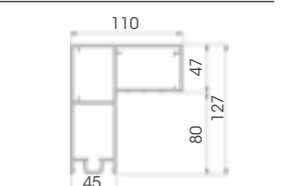

Door Frame



DFL 130x60



Length **5.800 mm**
Packing **2 pz / bag**
Colour **E**

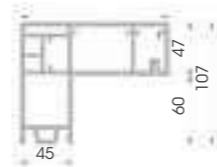

DFM 20

Length **5.800 mm**
Packing **4 pz / bag**
Colour **E**

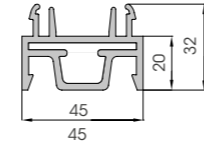

DFM 50

Length **5.800 mm**
Packing **2 pz / bag**
Colour **E**

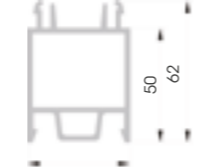

DFM 60

Length **5.800 mm**
Packing **2 pz / bag**
Colour **E**

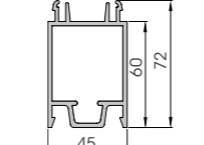

DFM 100

Length **5.800 mm**
Packing **2 pz / bag**
Colour **E**

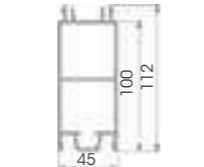

DCF

To install with TK 100 and TM 12

Length **5.800 mm**
Packing **2 pz / bag**
Colour **E**

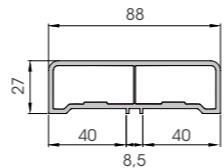

DCCF

Length **5.800 mm**
Packing **25 pz / bag**
Colour **various**

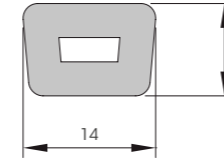

DFF

To install with DF 130

Length **5.800 mm**
Packing **25 pz / bag**
Colour **E**

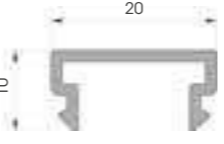

DCP DHC

To install with DF 130 and DFSH 130

Material **DCP plastic Ral 9010**
DHC aluminium
Length **5.800 mm**
Packing **25 pz / bag**

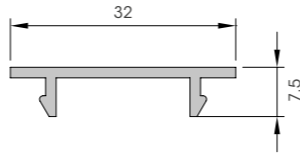

Door Frame



DJF DX DJF SX

Packing **10 pz / box**
Colour **E**



K1

Material **galvanized steel**
Packing **10 pz / bag**

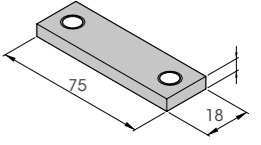

DC DX DC SX

Packing **10 pz / box**
Colour **E**

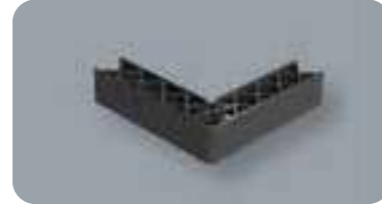

DCA

Packing **10 pz / box**
Colour **D**

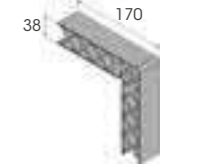

DCAS

Packing **20 pz / box**
Colour **D**

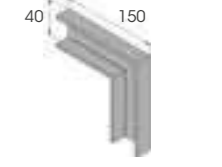

14 DOOR LEAF

Door profiles for continuous panels and foamed panels. Available in plastic to ensure thermal break.

Linea di profili porta per pannelli in continuo e schiumati. Disponibili in plastica per garantire l'isolamento termico.

Gamme de profilés pour portes frigorifiques à utiliser avec panneaux isolants réalisés par injection en continu de mousse polyuréthane. Ils sont disponibles en matière plastique pour garantir l'isolation thermique.

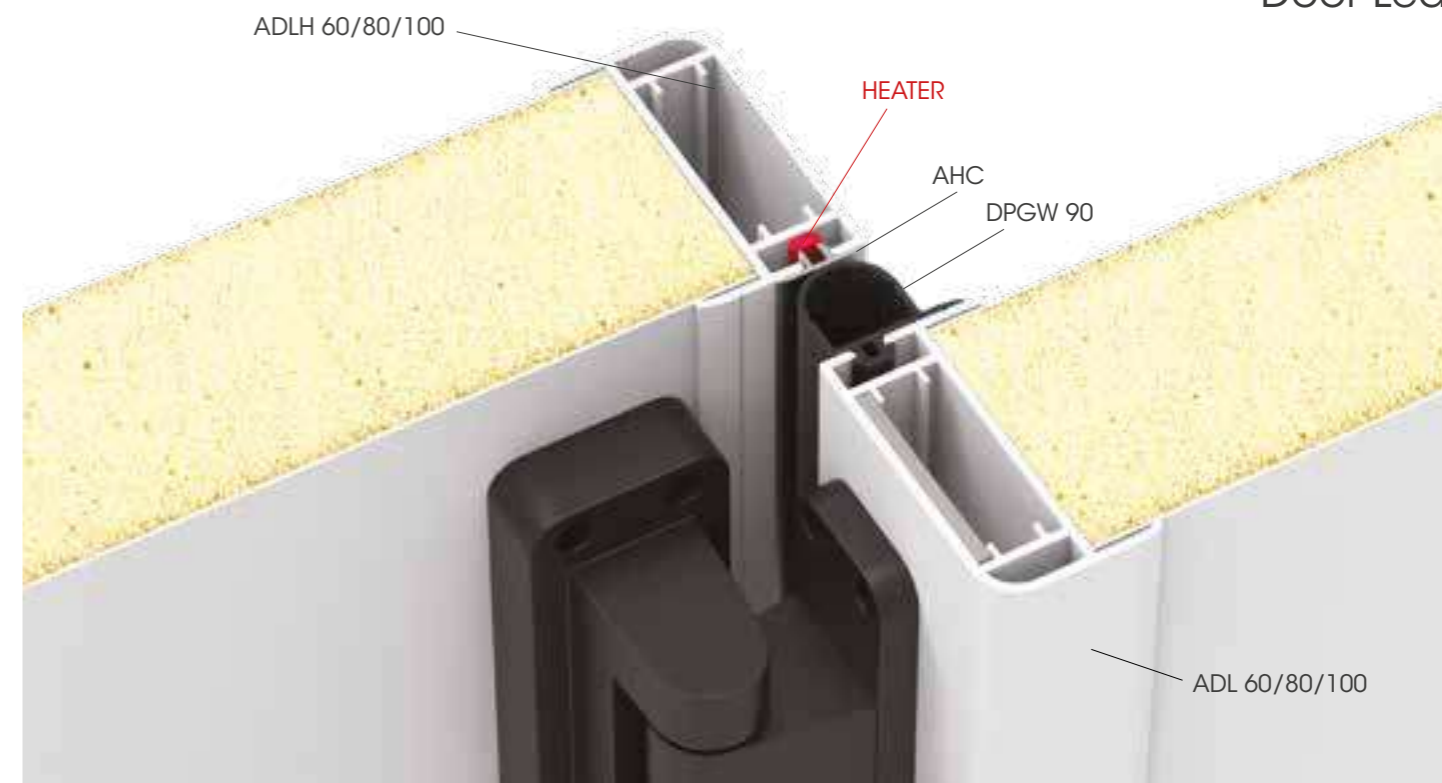



ADL 60
ADL 80
ADL 100
 To install with
 TM 12 - DPG 90 - DPGW 90
 DPGH 90 - DFG 90 - ADPG 90

Length **5.800 mm**
 Packing **2 pz / bag**
 Colour **E K**

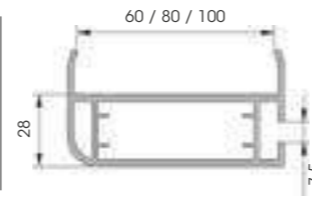

ADLA 60
ADLA 80
ADLA 100

Packing **ADLA 60 28 pz / box**
ADLA 80 20 pz / box
ADLA 100 16 pz / box
 Colour **K**

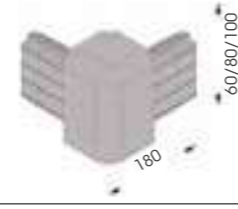

SQ ADL 60
SQ ADL 80
SQ ADL 100

Material **aluminium**
 Packing **20 pz / box**

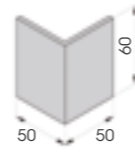

DL 70

Length **5.800 mm**
 Packing **4 pz / box**
 Colour **E K**

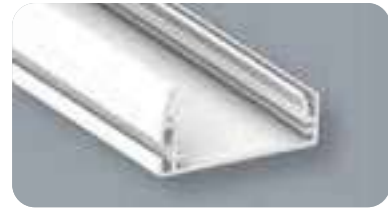
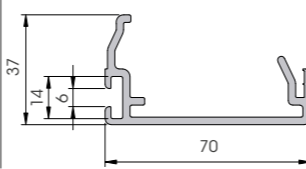

DL 90

Length **5.800 mm**
 Packing **2 pz / bag**
 Colour **E K**

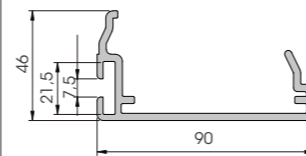

VANO 100



Length **5.800 mm**
 Packing **2 pz / bag**
 Colour **E K**

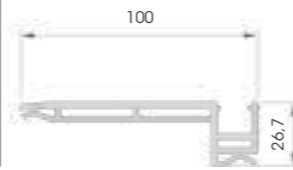

VHC

To install with VANO 100

Length **5.800 mm**
 Packing **24 pz / bag**
 Colour **K**

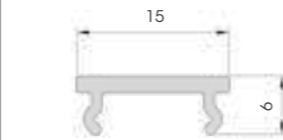

DW 60

Length **4.000 mm**
 Packing **10 pz / bag**
 Colour **E K**



DW 70

Length **4.000 mm**
 Packing **10 pz / bag**
 Colour **E K**

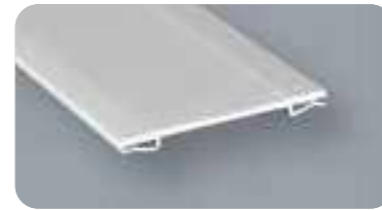
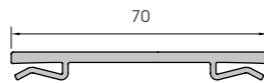

DW 80

Length **4.000 mm**
 Packing **10 pz / bag**
 Colour **E K**

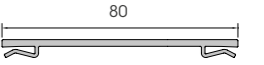

DW 100

Length **4.000 m m**
 Packing **10 pz / bag**
 Colour **E K**

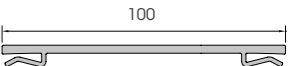

15 GASKETS



Linea di guarnizioni porta facili da installare. Disponibili sia per basse temperature che per temperature normali.

Complete range of door gaskets. Easy to install and available for both negative and normal temperatures.

Complète gamme de joints du périmètre-porte. Facile à installer et disponible pour les températures négatives et positives.

**NEW
CORNER
FOR
GASKETS**



KOLDENE

K

- Suitable for contact with food in accordance with EU and FDA regulations
- No EPDM
- Odorless
- 100% Recyclable
- PVC free
- Phthalate free
- High physical-chemical properties
- Working temperatures: from -50° to +110°
- Excellent elastic memory over time
- Flexible at low temperatures
- Excellent thermal endurance
- Waterproof
- Does not stain

**NEW
DPG 90
CLICK**

SOFT

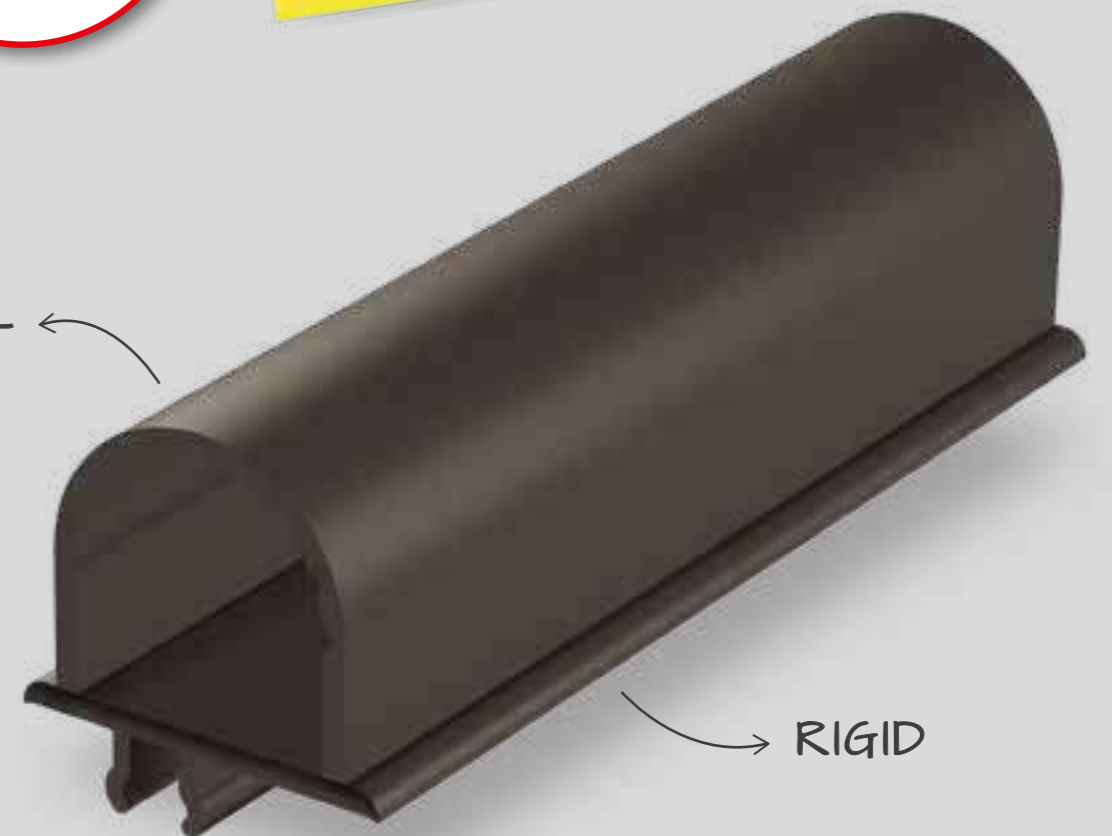

RIGID



DPG 70



Packing 1 pz / reel
L 80.000mm
Colour **D**

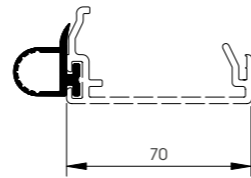

DPG W 70



Packing 1 pz / reel
L 80.000mm
Colour **D**

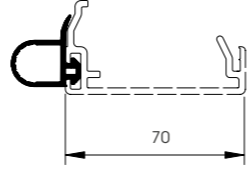

ADPG 70
To install with DPG 70
DPG W 70

Packing 50 pz / box
Colour **D**



DFG 70

Length 3.800 mm
Packing 12 pz / box
Colour **D**

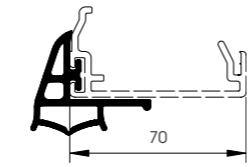

DPG 90



Packing 1 pz / reel
L 50.000 mm
Colour **D**

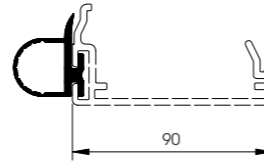

DPG W 90



Packing 1 pz / reel
L 60.000 mm
Colour **D**

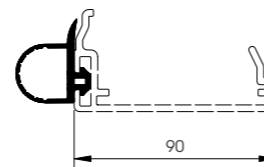

DPG H 90



Packing 1 pz / reel
L 60.000 mm
Colour **D**

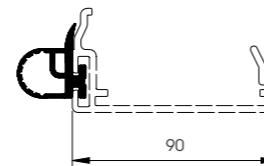

DPG 90 CLICK



Length 4.000 mm
Packing 6 pz / box
Colour **D**

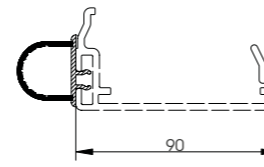

ADPG 90
To install with DPG 90
DPG W 90 - DPGH90
DPGH 90 - DPG 90 CLICK

Packing 40 pz / box
Colour **D**

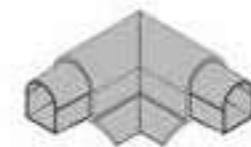

DFG 90

Length 3.800 mm
Packing 6 pz / box
Colour **D**

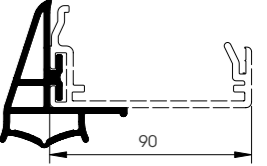

VELA



Length 3.700 mm
Packing 6 pz / box
Colour **D**

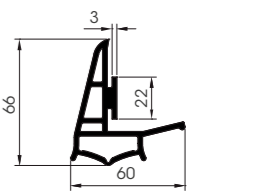

PLANE



Length 4.000 mm
Packing 15 pz / box
Colour **D**

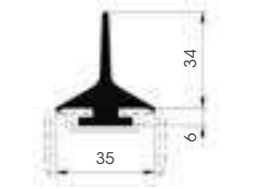

16

ACCESSORIES FOR PANEL



Profiles and moulded accessories to complete the panel finish. Practical for cleaning assuring good hygiene for the food industry.

Profilati e stampati per completare la finitura di pannelli. Pratici per la pulizia e l'igiene nel settore alimentare.

Profilé et pièces injectés pour la finition des panneaux. Utiles pour assurer le nettoyage et l'hygiène dans le domaine alimentaire.



**NEW
BREAKING
RESISTANCE
2.099 KG**



BAR 15
Breaking resistance with 660 Kg self-tapping screw Ø 6,3 mm

Length **on request**
Packing **boxes**
Colour **E**

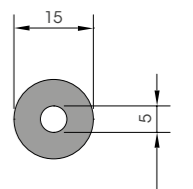

AC 40X40
Breaking resistance for meter 6033 Kg

Length **4.000 mm**
Packing **4 pz / bundle**
Colour **E**

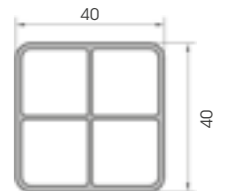

AC 60X30

Length **4.000 mm**
Packing **2 pz / bundle**
Colour **E**

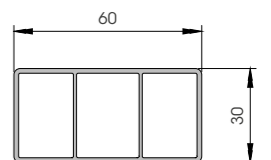





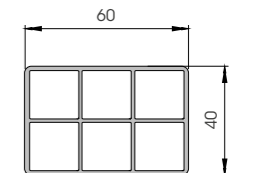



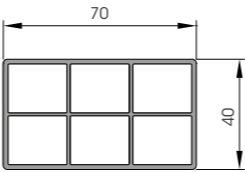

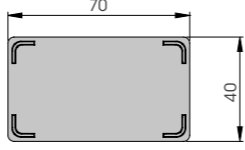

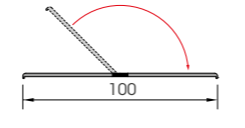

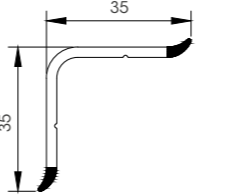

AC 60X40

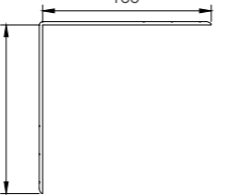
Length **4.000 mm**
Packing **2 pz / bundle**

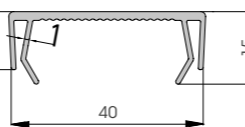

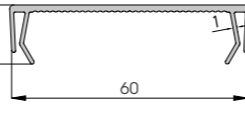
Accessories for panels

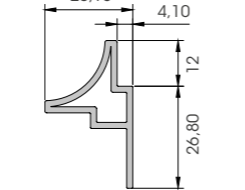
	AC 70X40 Breaking resistance for meter 6217 Kg *	Length 4.000 mm Packing 2 pz / bundle Colour E	
	ACT 70	Packing 100 pz / box Colour E	
	MC 50	Length 4.000 mm Packing 20 pz / box Colour E	
	L 35x35	Length 4.000 mm Packing 40 pz / bundle Colour E	
	L 120x60	Length 4.000 mm Packing 4 pz / bundle Colour E	
	L 150x150	Length 4.000 mm Packing 2 pz / bundle Colour E	
	SH 40	Length 4.000 mm Packing 32 pz / box Colour E	
	SH 60	Length 4.000 mm Packing 25 pz / box Colour E	
	CC NEW	Length 4.000 mm Colour E	

Accessories for panels

	CCT NEW	Packing to be defined Colour E	
	R 60	Packing 300 pz / box Colour E F	
	R 90 Available with hole Ø 14/20 mm	Packing 150 pz / box Colour E F	
	M 8 Medium breaking resistance 550 Kg M 10 Medium breaking resistance 520 Kg M 12 Medium breaking resistance 665 Kg *	Packing 300 pz / box Colour E F	
	M 8H M 10H M 12H	Packing 300 pz / box Colour E F	
	M 10 SI Medium breaking resistance 2.099 Kg * STEEL INSERT	Packing 300 pz / box Colour E F	
	DAD 12	Packing 1.000 pz / box Colour White	
	BAR 12	Length 500 mm Packing 100 pz / box Colour White	
	RON 12	Packing 1000 pz / box Colour White	

17 TRIMS

Complete range of profiles and accessories used to fix and to finish panels.

Gamma completa di profili e accessori per l'incastro e la finitura dei pannelli.

Gamme complète de profilés et d'accessoires pour le joint et la finition de panneaux.



PCC

Length **2.500 / 3.000 mm**
Packing **30 pz / box**
Colour **E**

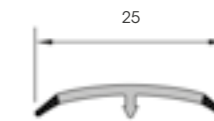

PCB

Length **2.500 / 3.000 mm**
Packing **30 pz / box**
Colour **White**

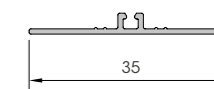

PCS

Length **2.500 / 3.000 mm**
Packing **30 pz / box**
Colour **E**

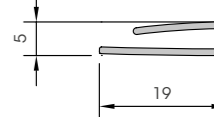

PDB

Length **2.500 / 3.000 mm**
Packing **30 pz / box**
Colour **E**

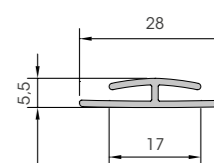

PCI

Length **2.500 / 3.000 mm**
Packing **30 pz / box**
Colour **E**

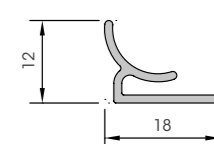

PCO

Length **2.500 / 3.000 mm**
Packing **30 pz / box**
Colour **E**

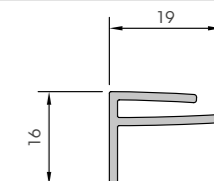

PCC HY



Length **2.500 / 3.000 mm**
Packing **30 pz / box**
Colour **E**

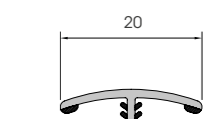

PCB HY



Length **2.500 / 3.000 mm**
Packing **30 pz / box**
Colour **E**

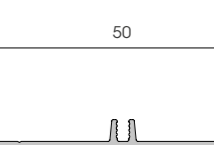

18

T SUSPENSION ALUMINIUM PROFILES

**CERTIFICATED
BREAKING RESISTANCE**



T and Omega profiles for ceiling suspension. White painted aluminium profiles, fire resistance and equipped with stainless steel nuts covered in plastic to ensure thermal bridge. Two solutions available, one light and one heavy.

Profili a T e Omega per soffitto a sospensione. Realizzati in alluminio verniciato bianco, resistenti al fuoco e provvisti di dadi in acciaio ricoperti in plastica che fungono da taglio termico. Disponibili 2 soluzioni, una leggera e una pesante.

T et Omega profilés pour la suspension de plafond. Blanc laqué profilés en aluminium, résistants au feu et équipés d'écrous en acier inox recouverts de plastique pour garantir le pont thermique. Deux solutions disponibles, une légère et une lourde.



T Suspension



T 85
*

Length **4.000 mm**
Packing **6 pz / bundle**
Colour **E F**

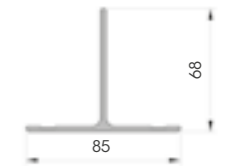

T 130
*

Length **4.000 mm**
Packing **4 pz / bundle**
Colour **E F**

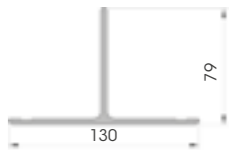

OME 110
*

Length **4.000 mm**
Packing **4 pz / bundle**
Colour **E F**



OME 150
*

Length **4.000 mm**
Packing **2 pz / bundle**
Colour **E F**



CEBES 100
*

Length **4.000 mm**
Packing **5 pz / bundle**
Colour **E F**



CEBES 130
*

Length **4.000 mm**
Packing **3 pz / bundle**
Colour **E F**



OMES S



Packing **50 pz / box**
Colour **E**

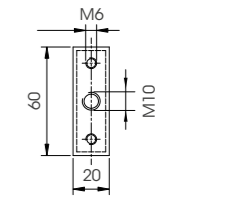

OMES L



Packing **50 pz / box**
Colour **E**

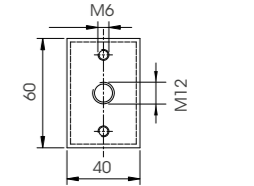

**SJ8
SJ10
SJ12**

Material **galvanized steel**
Packing **50 pz / box**

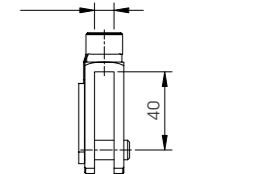

* Loading tests available on request

19 BUMPER 30

Small bumper to be used on refrigerated cabinets and check-outs, easy set up for installing profiles on pvc guide, available in soft or rigid pvc.

Paracolpi di piccole dimensioni ideale per vetrine refrigerate e check outs, facile da installare con rapido fissaggio tramite incastro su guida in pvc, disponibile in materiale rigido o morbido.

Profilé anti-choc de petits dimensions idéal pour les vitrines réfrigérées et les compteurs, facile à installer avec fixation rapide par le support en pvc disponible en matériel dur ou souple.

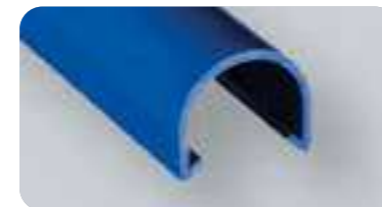
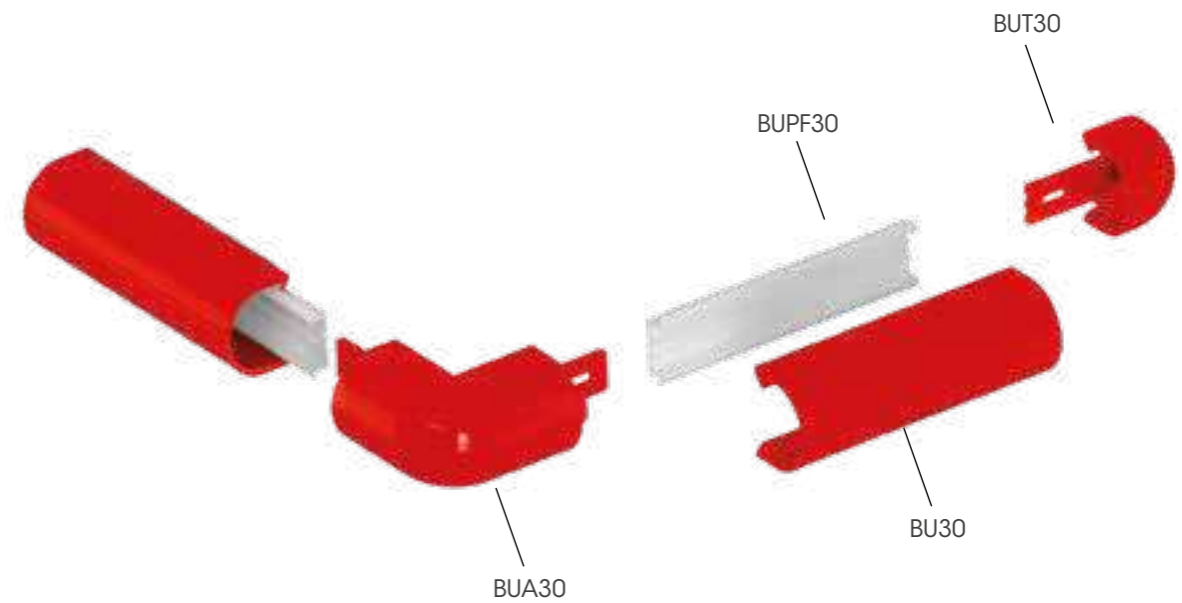

BU 30

Length **4.000 mm**
Packing **22 pz / box**
Colour **A B M D**
G H N

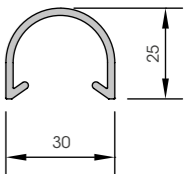

BU 30 flex

Minimum radius: 60 mm

Packing **2 pz / box**
L = **22.000 mm**
Colour **A B M D**
F G H I
N

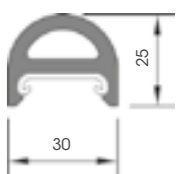

BUPF 30

Length **4.000 mm**
Packing **22 pz / box**

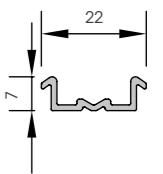

BUT 30

Packing **100 pz / box**
Colour **A B M D**
F G H I
N

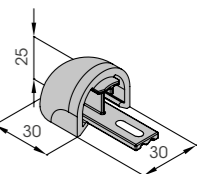

BUA 30

Packing **50 pz / box**
Colour **A B M D**
F G H I
N

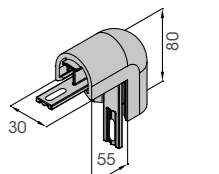

For some colours minimum quantity per order is required

20 BUMPER 50

Highly resistant against impacts, linear but functional design, high resistant, easy to install and equipped with accessories.

Profilo paracolpi dal design semplice e funzionale. Resistente, facile da installare e completo di accessori.

Profilé anti-choc avec un design simple et fonctionel. Résistant, facile à installer et fourni entièrement équipé.

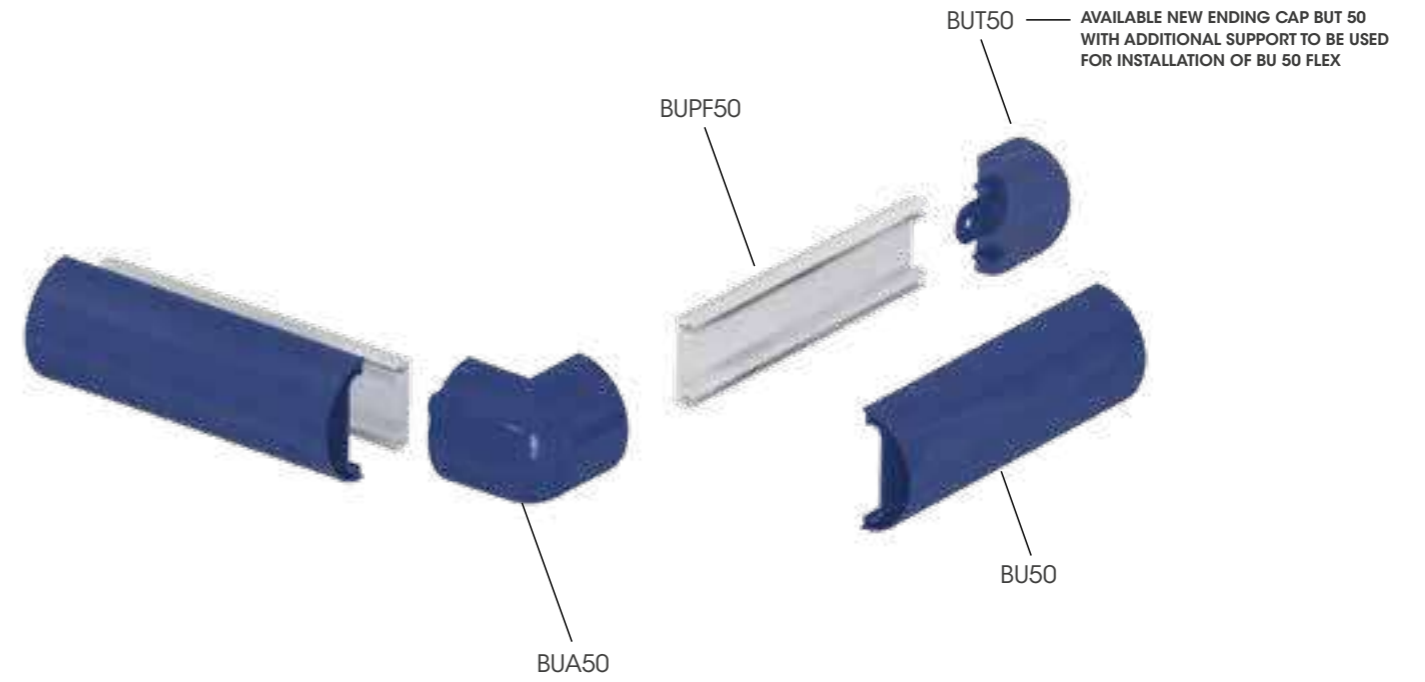

BU 50

Length **4.000 mm**
Packing **14 pz / box**
Colour **A B M D**
G H N

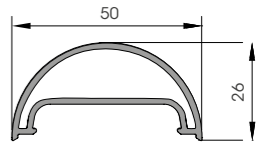

BU 50 flex

Minimum radius: 250 mm

Length **4.000 mm**
Packing **14 pz / box**
Colour **A B M D**
F G H I
N

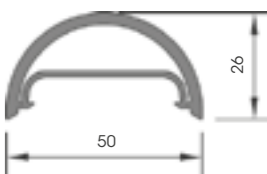

BUPF 50

Length **4.000 mm**
Packing **14 pz / box**

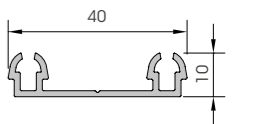

BUT 50

Packing **50 pz / box**
Colour **A B M D**
F G H I
N



BUA 50

Packing **50 pz / box**
Colour **A B M D**
F G H I
N

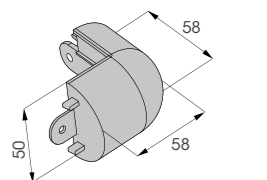

For some colours minimum quantity per order is required

21 BUMPER 80

Without guides, this profile is directly fixed to the wall through hidden screws covered by a specific item available in various colours.

Articolo paracolpi a fissaggio diretto alla parete tramite viti nascoste da un apposito profilo disponibile in vari colori.

Profilé anti-choc à fixation directe aux murs grâce à des vis cachées par un profilé disponible en plusieurs couleurs.

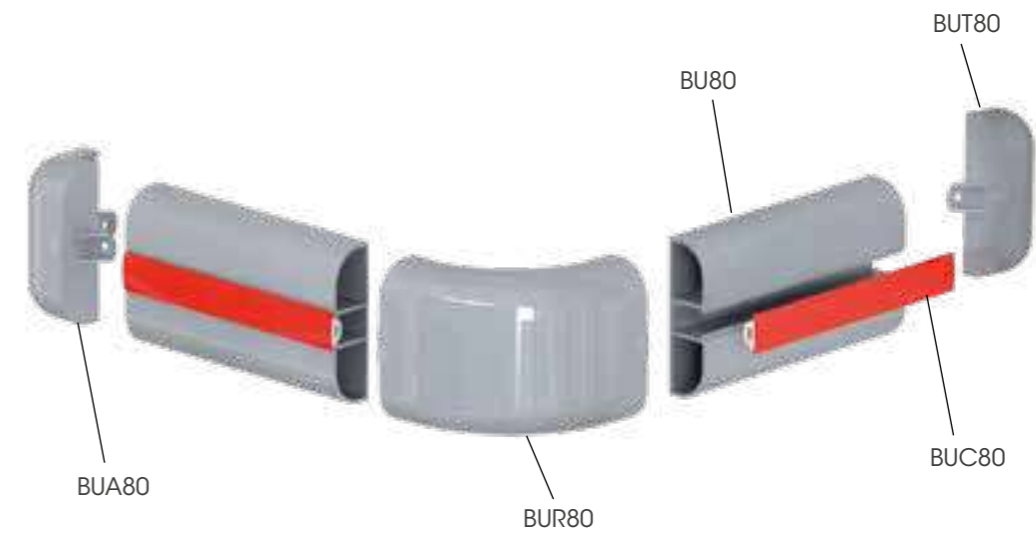

BU 80

Length **4.000 mm**
Packing **6 pz / box**
Colour **B N**

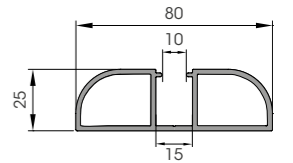

BUC 80

Length **60 mt / reel**
Packing **cardboard reel**
Colour **A B M D G H N**

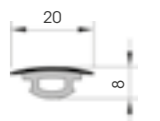

BUT 80

Packing **50 pz / box**
Colour **B N**

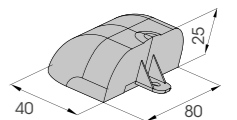

BUA 80

Packing **50 pz / box**
Colour **B N**

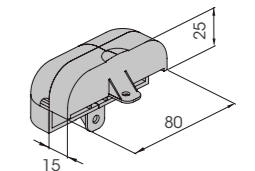

BUR 80

Packing **25 pz / box**
Colour **B N**

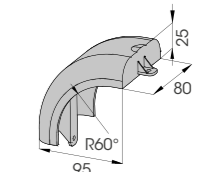

22

BEND 80

Unique in range and shape, a forceful choice between convenience and stylish design. Corner caps are not necessary.

Articolo unico nel suo genere, compromesso tra praticità e design elegante. Si adatta alla parete senza l'ausilio di raccordi.

Article unique en son genre, parfait compromis entre la praticité et le design élégant. Il s'adapte au mur sans avoir besoin d'embouts supplémentaires.

PATENTED
BREVETTATO

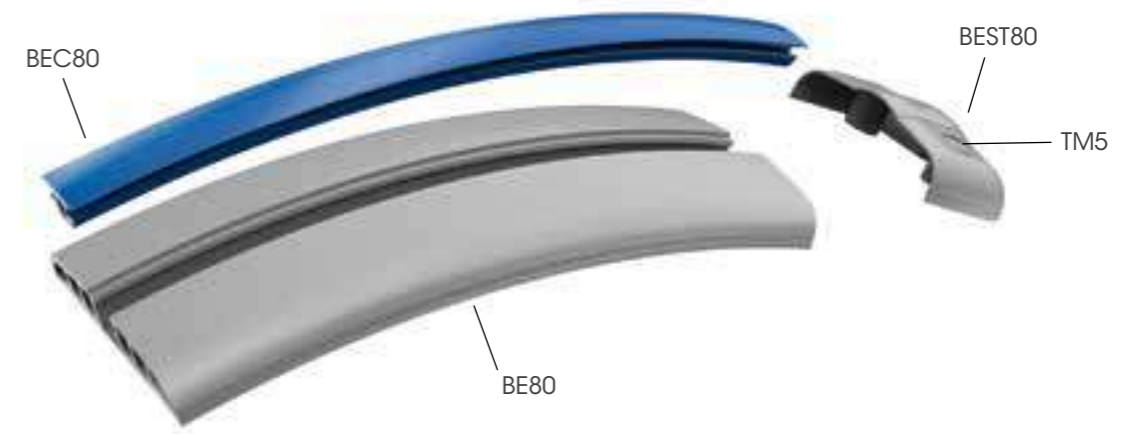

BES 80
With double-sided tape
Minimum radius: 40 mm

Packing 1 pz / box
L= 25.000 mm
Colour **T**
+ colored strip
A **I**

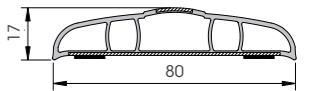

BE 80 with tape
BE 80 with screws
Minimum radius: 40 mm
To install with **BEC 80**

Packing 1 pz / box
L = 25.000 mm
Colour **T**

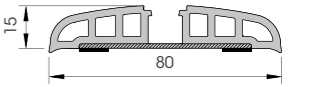

BER 80
To install with **BEC 80**

Length 4.000 mm
Packing 12 pz / box
Colour **B** **K**



BEC 80

Length 60 mt / reel
Packing cardboard reel
Colour **A** **B** **E** **G**
T

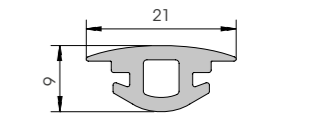

BEST 80
To install with **TM5**

Packing 50 pz / box
Colour **B** **I** **K**

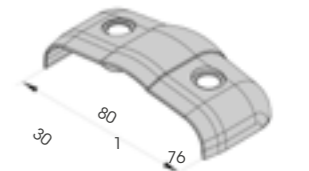

BEJ 80
With double-sided tape

Packing 50 pz / box
Colour **T**

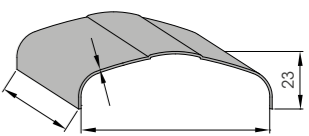

23

BUMPER SUPERFLEX 80

New flexible model of classic BU80, produced in coextruded material, features versatility and elegance, easy to install and shockproof.

Nuovissima versione del classico BU 80, prodotto in materiale coestruso, coniuga versatilità ed eleganza alle immancabili doti tecniche quali facilità di montaggio e resistenza all'urto.

Nouvelle version de classique BU80, produit en matériel co-extrudé, mélange polyvalence et élégance aux caractéristiques techniques tels que la facilité à l'assemblage et la résistance aux chocs.



Bumper Superflex 80

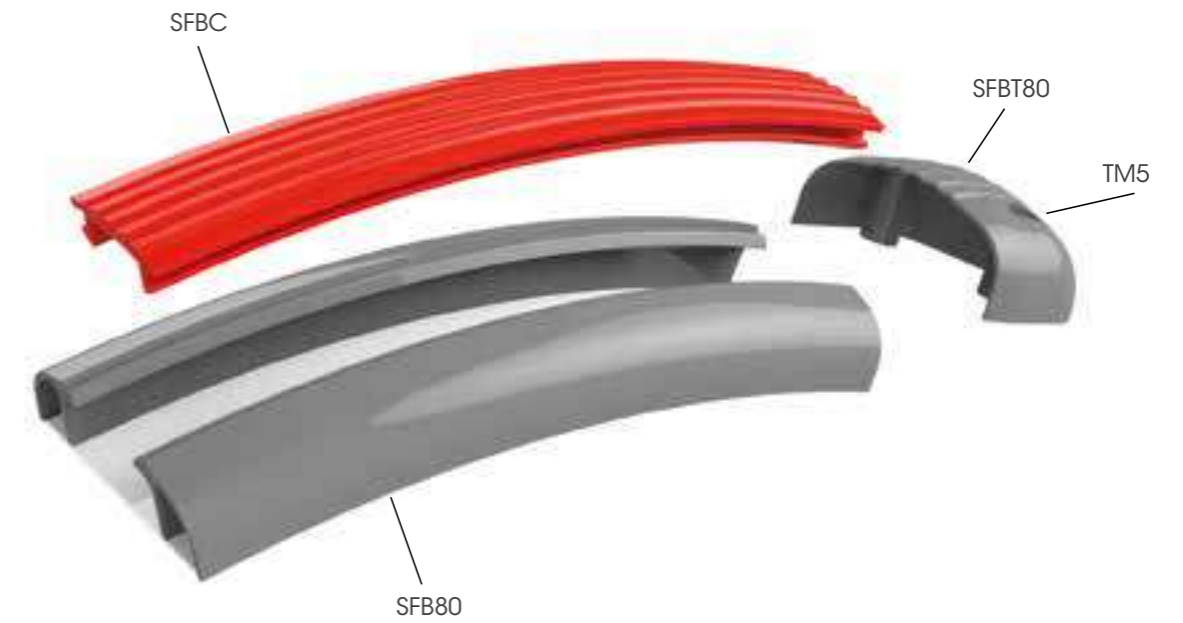

SFB 80

Packing **1 pz / box**
L = 10.000 mm
Colour **I**



SFRB 80

Length **4.000 mm**
Packing **5 pz / box**
Colour **B**



SFBC

Packing **2 pz / box**
L = 40.000 mm
Colour **A G T**

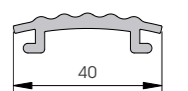

SFBT80

To install with TM5

Packing **50 pz / box**
Colour **B I**

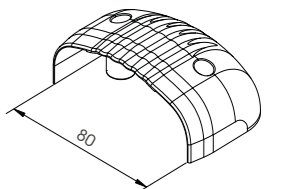

24

BUMPER MODULAR

New modular antischock profile with hidden screws. You can enlarge the protecting surface by adding simple profiles, economic and easy to clean.

Nuovo profilo paracolpi modulare con viti a scomparsa. Possibilità di aumentare la superficie di protezione con l'aggiunta di semplici profili, economico e facile da pulire.

Nouveau profilé modulable anti-choc avec attaches cachées. Vous pouvez élargir le profilé et la surface protégée en ajoutant simplement des profilés, économique et facile à nettoyer.

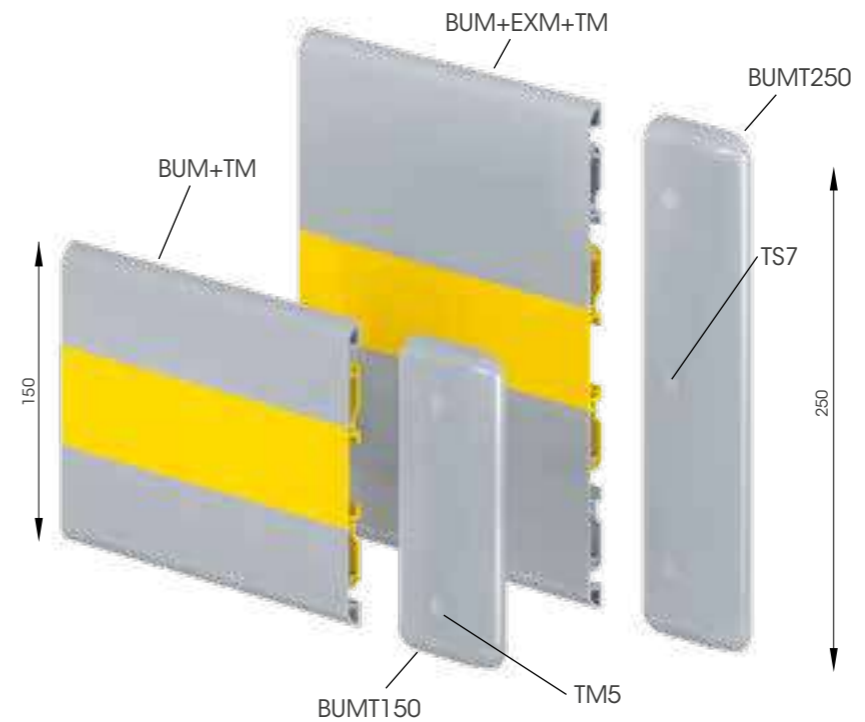

BUM

Length 4.000 mm
Packing 8 pz / box
Colour A B M E G H

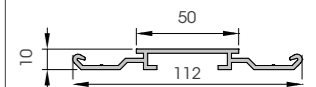

TM

Length 4.000 mm
Packing 40 pz / box
Colour B E

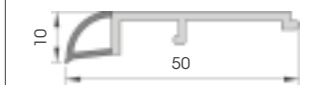

EXM

Length 4.000 mm
Packing 20 pz / box
Colour B E

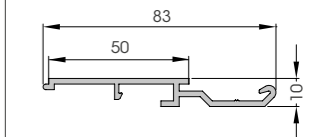

BUMT 150

To install with TM5

Packing 50 pz / box
Colour B E

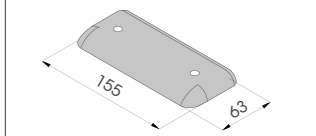

BUMT 250

To install with TS7

Packing 25 pz / box
Colour E

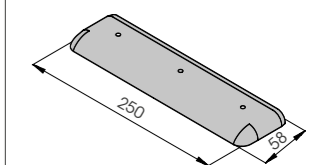

For some colours minimum quantity per order is required

25 WALL PROTECTION

New bumper without guides. Thanks to its big size and resistance it is ideal for protection of industrial spaces. Fixed caps with hidden screws covered by specific buttons.

Nuovo profilo antiurto senza guida. La sua ampiezza e resistenza lo rende ideale per la protezione di ambienti industriali. Terminali fissati con viti nascoste da appositi bottoni.

Nouveau profilé anti-choc sans besoin d'une base à fixer. Sa mesure large et sa résistance en font le profilé parfait pour la protection des espaces industriels. Embouts fixés avec des vis cachées grâce à des bouchons spécifiques.

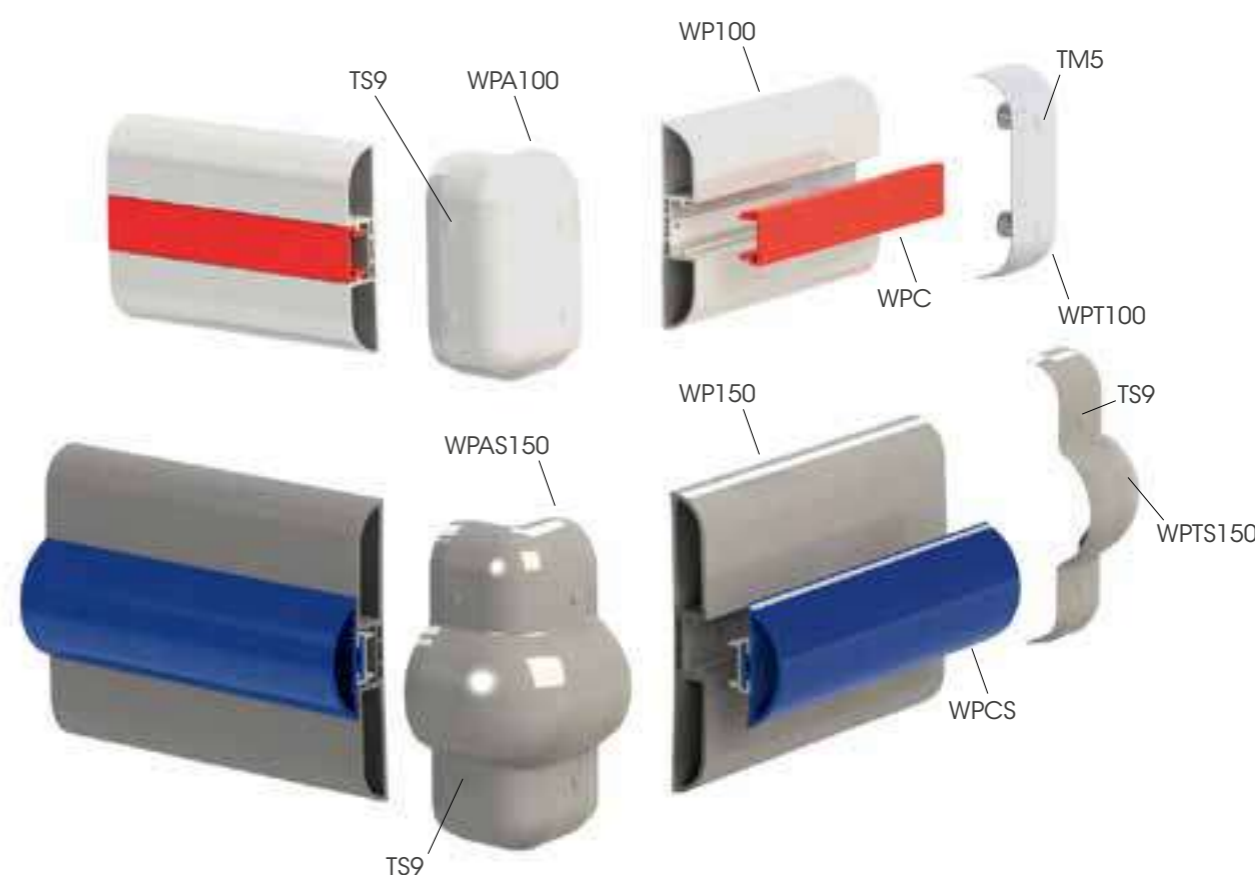

WP 100

Length **4.000 mm**
Packing **8 pz / box**
Colour **B E F**

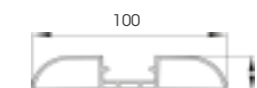

WP 150

Length **4.000 mm**
Packing **4 pz / box**
Colour **B E M**

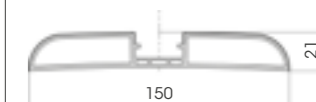

WPC

To install with WP 100 / WP 150

Length **4.000 mm**
Packing **16 pz / box**
Colour **A B D E F G H M**

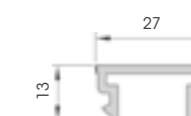



WPT 100
To install with TM5

Packing Colour **50 pz / box**
B E F

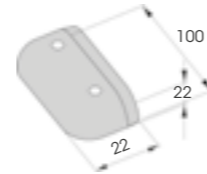

WPA 100
To install with TS9

Packing Colour **20 pz / box**
B E

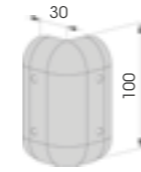

WPT 150
To install with TM5

Packing Colour **50 pz / box**
B E

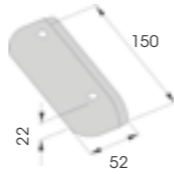

WPA 150
To install with TS9

Packing Colour **20 pz / box**
B E

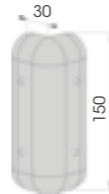

WPCS
To install with WP 100 / WP 150

Length **4.000 mm**
Packing Colour **8 pz / box**
A B M D E
F G H I



WPTS 100
To install with TS9

Packing Colour **20 pz / box**
B E

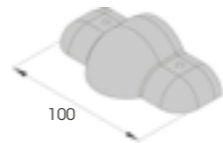

WPAS 100
To install with TS9

Packing Colour **20 pz / box**
B E

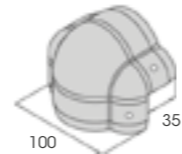

WPTS 150
To install with TS9

Packing Colour **20 pz / box**
B E

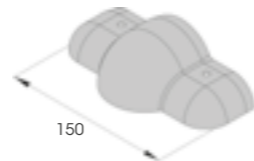

WPAS 150
To install with TS9

Packing Colour **20 pz / box**
B E

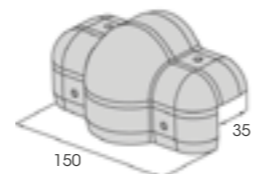

WALL HUG 1000
2000
3000
4000

Length **1000/2000/3000/4000**
Packing Colour **unpacked**
M

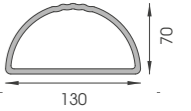

WALL BFLEX 1000
2000
3000
4000

Length **1000/2000/3000/4000**
Packing Colour **unpacked**
M

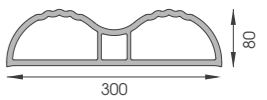

WALL BFLEX MODULAR

Packing Colour **unpacked**
M

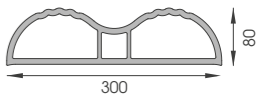

26 BUMPER 150

Soft but strong material.
Innovative and simple design.

Profilo antiurto in materiale morbido
ma indistruttibile. Design semplice
e versatile.

Profilé anti-choc réalisé avec un matériel
souple et rigide indestructible.
Design simple et innovant.



Bumper 150

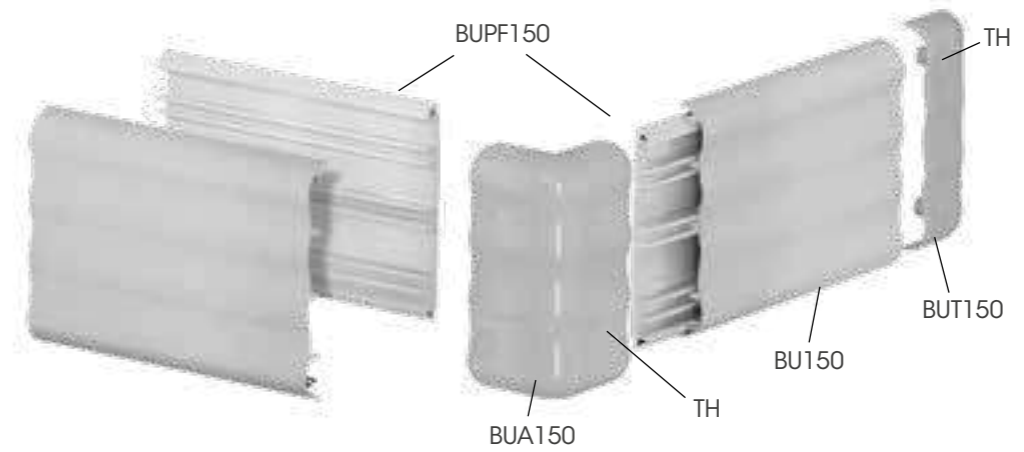

BU 150

Packing **1 pz / box**
L = 25.000 mm
Colour **I L**

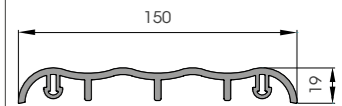

BUS 150

Length **4.000 mm**
Packing **6 pz / box**
Colour **B**

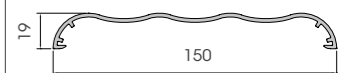

MU 20

To install with BUS 150

Packing **1 pz / box**
L = 48.000 mm

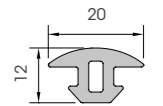

BUPF 150

Length **4.000 mm**
Packing **6 pz / bag**

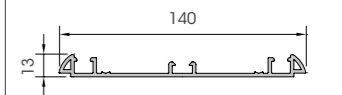

BUT 150

To install with TH

Packing **50 pz / box**
Colour **B I L**

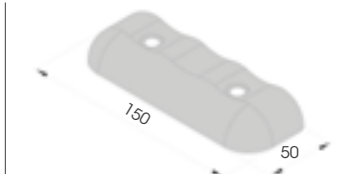

BUA 150

To install with TH

Packing **20 pz / box**
Colour **B I L**

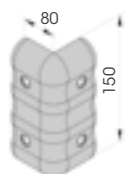

27 BUMPER FLOOR

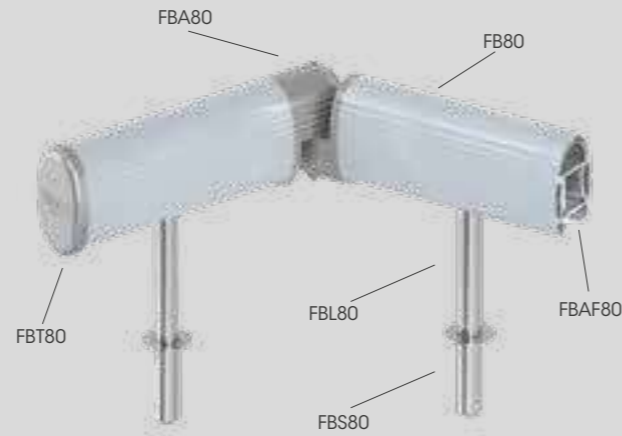

Spacer floor bumper to protect refrigerated cabinets and walls, fully equipped with corners and accessories necessary to assemble it.

Sistema di protezione distanziale a terra di banchi frigo e pareti, completo di curve e provvisto di accessori.

Système de protection au sol, épaisseur pour les vitrines réfrigérées et murs, pleine de courbes et équipé d'accessoires.



Bumper Floor



FB 80



Length **4.000 mm**
Packing **6 pz / box**
Colour **B**

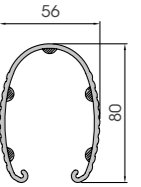

FBAF 80

Material **aluminium**
Length **4.000 mm**
Packing **6 pz / box**

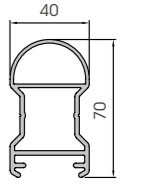

FBT 80

Equipped with screws

Material **aluminium**
Packing **40 pz / box**

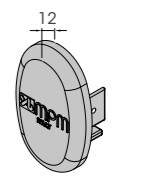

FBA 80

Equipped with screws

Material **aluminium**
Packing **8 pz / box**

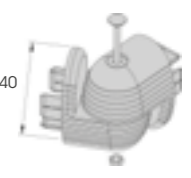

FBL 80

Equipped with screws

Material **stainless steel**
Packing **20 pz / box**

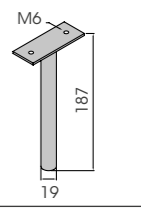

FBS 80

Material **stainless steel**
Packing **20 pz / box**

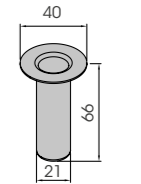

FR

Material **chemical anchor**
Packing **1 pz / box**

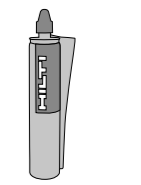

FBR

Material **steel**
Length **400 mm**
Packing **to be defined**

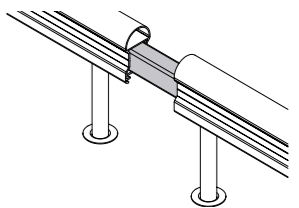

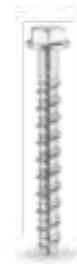

S12 GALVANISED STEEL

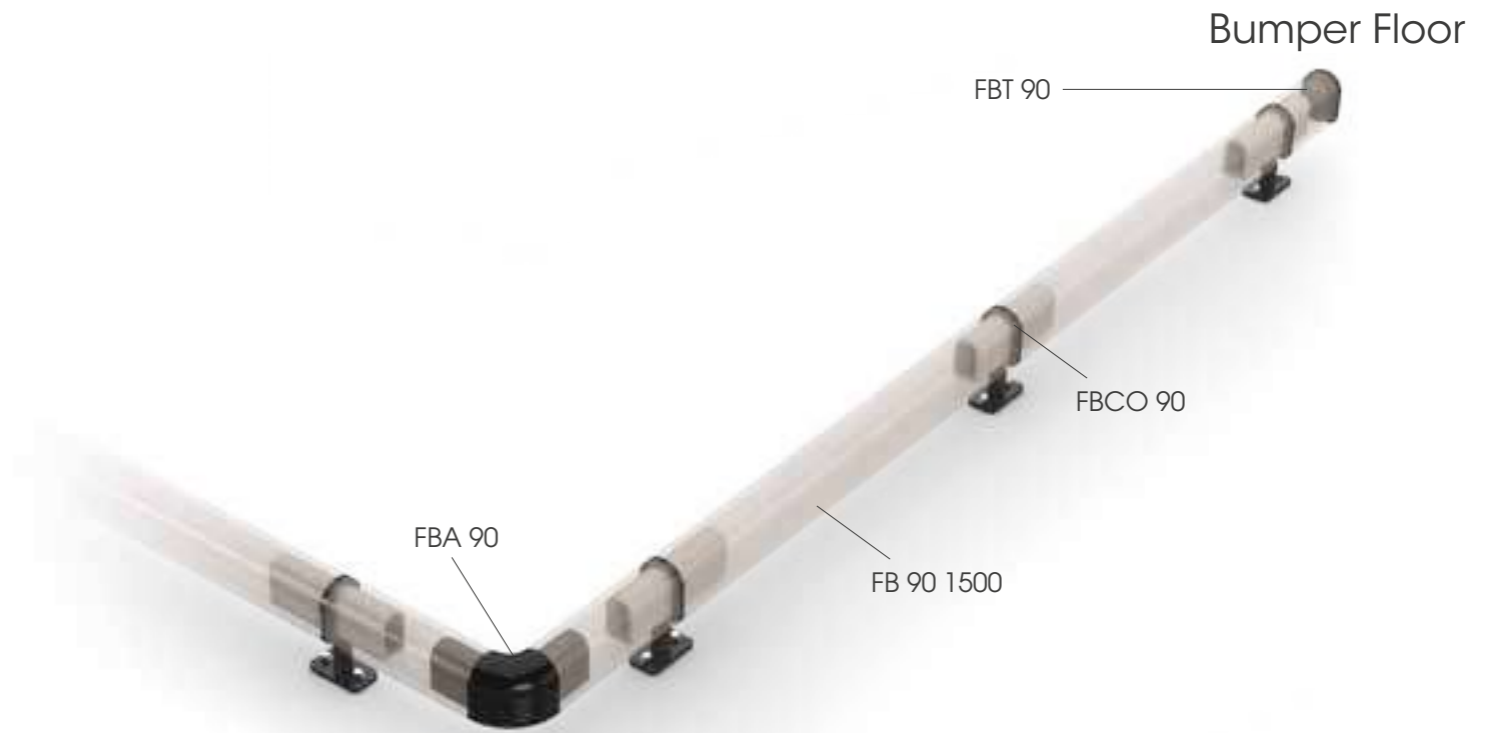

FB 90 2000

Length **2000 mm**
Packing **to be defined**
Colour **B**

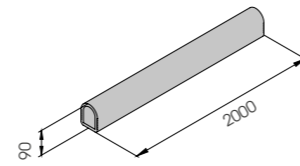

FBCO 90

Packing **2 pz / box**
Colour **B**

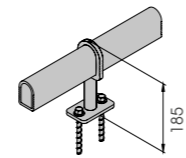

Equipped with accessories



FBT 90

Packing **2 pz / box**
Colour **D**

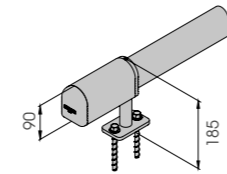

Equipped with accessories



FBA 90

Packing **2 pz / box**
Colour **B D**

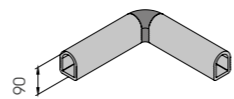

28 WHEEL SYSTEM

Complete system for sliding glass doors of refrigerated displays. Shockproof pvc profiles equipped with accessories to ensure a good insulation and consequently a considerable energy saving. A lower rail is installed to allow the easy sliding opening and closing of doors.

Sistema completo per le porte scorrevoli a vetro degli armadi a muro. Profili realizzati in pvc antiurto completi di accessori che assicurano un buon isolamento e di conseguenza un notevole risparmio energetico. Dotato di sistema di scorrimento che rende agevole l'apertura e la chiusura delle porte.

Système complet pour les portes coulissantes en vitre de vitrines réfrigérées. Profils en pvc antichoc équipés d'accessoires pour assurer une bonne isolation et donc une économie d'énergie considérable. A rail inférieur est installé pour permettre le coulisement pratique de l'ouverture et de la fermeture des portes.

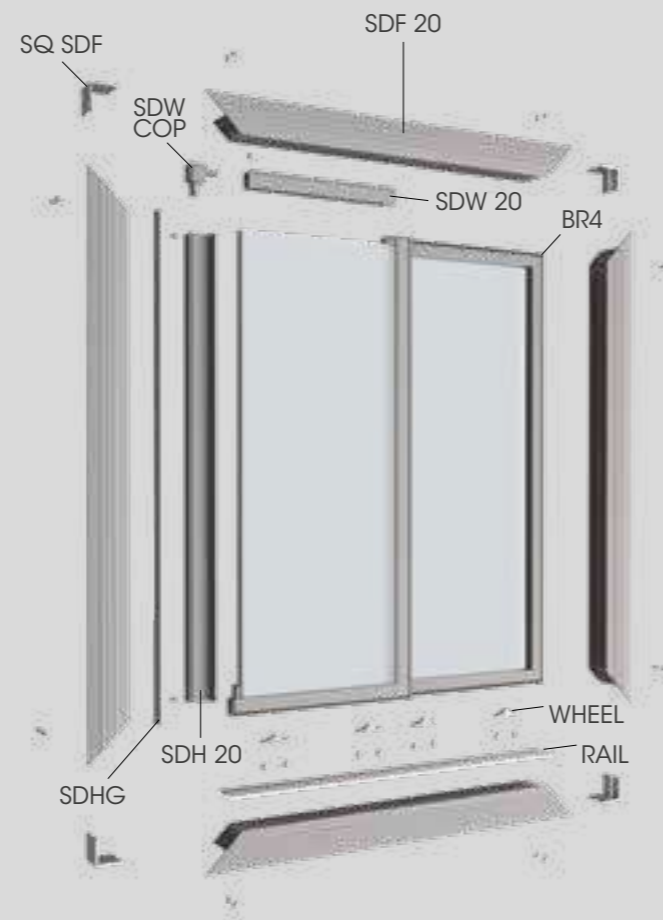

Wheel System

	SDF 20	Length Packing Colour	4.000 mm 5 pz / box B D	
	SDF 20 SHORT	Length Packing Colour	4.000 mm 5 pz / box B D	
	SDW 20	Length Packing Colour	4.000 mm 20 pz / box B D	
	SDH 20	Length Packing Colour	4.000 mm 12 pz / box B D	
	SDHG	Packing Colour	60 mt reel B D	
	RAIL 2	Material Length Packing	aluminium 3.000 mm 10 pz / bundle	
	WHEEL	Material Packing	steel 100 pz / box	
	SQ SDF To install with SDF	Material Packing	aluminium 100 pz / box	
	SDW COP To install with SDW 20 and SDH 20	Packing Colour	100 pz / box B D	
	BR 4.5 BR 9	Packing Colour	BR 4.5 1 pz / reel L 600 mt BR 9 1 pz / reel L 225 mt D	



Fixing accessories

TH
ABS.
100 Pcs. / bag.
RAL 9010 / 9002 / 9006 / 7040 / 7024 / Transparent.

TX12
ABS.
100 Pcs. / bag.
RAL 7035 / 9010

TS5
Hole required Ø 5
White nylon.
250 Pcs. / bag.

TB14
Hole required Ø 4.
Steel / aluminium. / RAL 9010
500 Pcs. / box.

TS7
Hole required Ø 5.
White or grey nylon.
250 Pcs. / bag.

TB20
Hole required Ø 5.
Steel / aluminium.
500 Pcs. / box.

TS9
Hole required Ø 5.
White or grey nylon.
250 Pcs. / bag.

TF14
Hole required Ø 5.
Aluminium.
500 Pcs. / box.

TM5
Hole required Ø 8.5
Neutral polyethylene.
100/500 Pcs. / bag.

TF20
Hole required Ø 6.5.
Aluminium.
500 Pcs. / box.

TM12
Hole required Ø 20.
PE, RAL 9010.
100 Pcs. / bag.

TK100
Hole required Ø 5 and 20.
Steel screw. Packing on demand.

Colours

- | | | | | | | | | | | | | |
|-----------------------------|------------------------------|-------------------------------|-------------------------------|-------------------------------|------------------------------|-------------------------------|--------------------------------|------------------------------------|-----------------------------------|--------------------------------------|-------------------------------|--|
| A
RED
RAL 3002 | B
GREY
RAL 7040 | D
BLACK
RAL 9005 | E
WHITE
RAL 9010 | F
WHITE
RAL 9002 | G
BLUE
RAL 5005 | H
GREEN
RAL 6029 | I
SILVER
RAL 9006 | K
LIGHT GREY
RAL 7035 | L
DARK GREY
RAL 7024 | M
LIGHT YELLOW
RAL 1018 | N
WHITE
RAL 9003 | O
STAINLESS GREY
RAL 9023 |
|-----------------------------|------------------------------|-------------------------------|-------------------------------|-------------------------------|------------------------------|-------------------------------|--------------------------------|------------------------------------|-----------------------------------|--------------------------------------|-------------------------------|--|

- | | | |
|-------------------|-------------------------|---|
| Cleaner resistant | Long resistance | Non toxic |
| Quick assembly | Good waterproof | Class V0 self-extinguishing fire resistance |
| Shockproof | Easy to clean | |
| Cheap | Good thermal insulation | |

YES NO

All pictures are for illustrations purposes only. The company reserves the right to make changes in dimensions, colours, material and packaging without prior notice.



M.P.M. s.r.l.
Via Europa 2
35010 Fratte
di S. Giustina in Colle
Padova · Italy

T +39 049 9301773
F +39 049 9300427
info@mpmpvc.com
mpmpvc.com

FEBRUARY 2022